

Unleashing the Power of DCC



Digital

plus
by Lenz



SET-01/4 Operations Manual

art. no. 60000
November 2000
Version 3.1



Welcome!

We would like to congratulate you on your acquisition of the

Digital plus by Lenz® SET-01 and we hope you will enjoy working with this model-railway control system.

The purpose of this operating manual is to explain the use of the Set and its components to you. In order to proceed as quickly as possible to the pleasure of operating your model railway with DCC, begin by reading the section "First Steps". After you have operated your first train you will be better able to follow the step by step description of SET-01's entire range of functions. It is not necessary to understand or use all the system's features. Select the set of features you are comfortable with and enjoy your model railroad.

If you still have questions, for which you can not find the answers even after reading this operating manual, please contact us. We will be happy to help you. There are four different ways of contacting Lenz Elektronik GmbH:

	Europe	North America
Postal address:	Lenz Elektronik GmbH Huettenbergstrasse 29 D-35398 Giessen	Lenz Agency PO Box 143 Chelmsford, MA 01824
Phone	++49 (0) 6403 900 133	++1 978 250 1494
Fax	++49 (0) 6403 900 155	++1 978 455 LENZ
Email	info@digital-plus.de	support@lenz.com

Do you have everything?

Please check, whether all the components of the SET-01 have been delivered:

LH100 - Keyboard based Dispatcher's Throttle

LV101 - Power Station (Booster)

LE102XF-WH or LE077XF - locomotive decoder

one 4- and one 3-terminal green connector attached to the rear of the LV101

one 6, one 4, and one 3-terminal green connector attached to the rear of the LZ100

operating manual (this booklet)

If an item is missing, please contact your retailer to have the missing item replaced.

1 Important information — Please read first!

Each component of your **Digital plus by Lenz**® Set-01 system was subjected to intense testing before shipping. Lenz Elektronik GmbH guarantees problem free operation when you follow these directions:

This manual contains all the possible LH100 capabilities present when used with an LZ100 V3. If you are using a different command control system, the LH100 capabilities may be reduced by the capabilities provided by that system. For details check out the system manual of the system you desire to use your LH100 on.

Your Set-01 system must only be used with components that have been branded to support XpressNet or the older X-Bus protocols. A branded system will display the XpressNet logo. Any other use than the one described in this operation manual is not allowed and will lead to voiding of the warranty.

Even when other devices (including ones from other manufacturers) have the same connectors, you may not operate your Set-01 with these devices unless they display the XpressNet logo. Other systems may use the same connectors but have different internal wiring that can harm the LZ100, LV101 or LH100.

Do not expose any system component to moisture.

☞ If you have problems,

please first check this operation manual to see if you may have missed a direction for use. The table of contents and especially the section "Troubleshooting" will help you here.

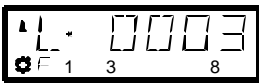

LH100 Configured with
German Display



LH100 Configured with
English Display

If you need to change the display language please refer to section 15.2.2 starting on page 69.

1.1 Method for describing commands within this manual:

This manual is written with the assumption that the LH100 is configured for the English language display. You can configure the LH100 for either English or German display. See section 14.2.2 for a description on how to configure the language of your LH100 display.

Showing step-by-step directions:

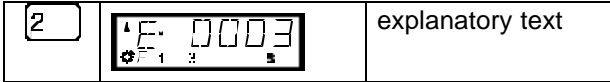

The entries that you must make using the LH100 keys are shown on the left. In the middle you will see what is shown on the display after the keystroke. To the right a brief explanation is provided.

All the described steps assume that the hand held controller is connected to a Version 3.0 **Digital plus by Lenz**® system, and that this system is turned on.

Showing displays and keys in text:

"E 0001" 'Enter'

In most cases the display of LH100 is showed as a picture, as are the keys. If the main text makes reference to displays, then it is put in double quotes. Keys referred to in the text are shown with single quotes.

Cross references:

(⇒p. 23)

This arrow points you to a particular page in this operation manual, where you will find additional information about the subject at hand.

Important notes:

 Text marked with this symbol and frame contains especially important information and tips.

2 Contents

1	Important information — Please read first!	3
1.1	Method for describing commands within this manual:	4
2	Contents	5
3	Quick Start Users Guide	7
3.1	Connection and initial operation	7
3.2	Operating Your first Train	9
4	System design overview of DIGITAL plus	12
4.1	Command Station LZ100	13
4.2	Installing the Command Station	13
5	Overview of the functions of LH100	15
5.1	Controlling locomotives	15
5.2	The function menu of LH100	16
6	The LH100 LCD Display	19
7	Controlling locomotives with the LH100	20
7.1	Changing locomotive speed and direction	20
7.2	Entering a new locomotive address on the LH100 keypad	20
7.3	Quickly toggling between 2 locomotive addresses	21
7.4	Selecting an address from the command station stack	22
7.5	Taking over control of a locomotive from another hand held controller	24
7.6	Activating locomotive functions	24
7.7	Showing and changing throttle-notches	26
8	Emergency stop and emergency off	28
8.1	Turning off the track power	28
8.2	Changing operating information during emergency stop/off	29
8.3	Switching turnouts during emergency stop	30
9	Configuring locomotive decoder functions	30
10	Double header	32
10.1	Prerequisites for creating a double header	33
10.2	Configuring two locomotives as a double header:	33
10.3	Combining locomotives with different speed step numbers into a double header	35
10.4	Error messages when assembling a double header	35
10.5	Disassembling a double header	36
11	Multi-unit consists (MU)	37
11.1	What is a multi-unit consist?	37
11.2	Prerequisites for a multi-unit consist:	38
11.3	Assembling a multi-unit consist (MU)	38
11.4	Controlling a multi-unit consist	40
11.5	Displaying the members of a MU and switching between locomotives in a MU	40
11.6	Removing a locomotive from a MU consist	41

11.7	Erasing a completed MU	42
11.8	Error messages in multi-unit consists	42
12	Throwing turnouts and setting signals	43
12.1	Feedback and display of the turnout position	44
12.2	Train operation while controlling turnouts or signals	45
13	Displaying feedback	46
14	Reading/Changing decoder settings	47
14.1	What is programming and what purpose does it serve?	47
14.2	Programming on the Main - PoM	50
14.3	Programming on the Programming track	54
14.4	Error messages during programming	65
15	Configuring the LH100 handheld using the SYS menu	66
15.1	SYS_0: entering the XpressNet device address	66
15.2	SYS_1: the system menu	67
15.3	SYS_7: Displaying the command station ID	74
15.4	SYS_8: Displaying the version number of the command station	74
15.5	SYS_9: Displaying the version number of LH100	75
16	Expanding SET-01	76
16.1	Adding XpressNet to allow additional input devices	77
16.2	More power through more power stations	78
17	Technical appendix	80
17.1	Error messages on the display	80
17.2	The LZ100 locomotive database	82
17.3	LZ100 Reset	82
17.4	Selecting suitable transformers for Set-01	82
17.5	Power Station LV101	83
17.6	Advice on the wiring of the model railway	88
17.7	Mixed operation: conventional DC and digital DCC	90
17.8	Wiring the XpressNet Data Network	91
17.9	Bits and bytes - Conversion calculation help	93
17.10	Glossary	94
18	Troubleshooting Guide	96
19	Radio And Television Interference	98
20	North American Warranty	99

3 Quick Start Users Guide

In this section you will learn about:

- the few steps that you need to know to operate your SET-01
- how to start your first test run

In the later sections, the whole range of functions of the SET-01 will be explained in detail.

3.1 Connection and initial operation

1. Plug the 5 pin din plug at the end of the LH100 cord into the 5 pin din socket that is located on the rear of the LZ100
2. Connect terminals J and K of the LV101 power station to the tracks of your model railway. You can pull off the green terminal connectors on the back of the LZ100 and LV101. This will facilitate the installation of cables. Make sure that no other transformers or operating controllers are connected to the tracks.

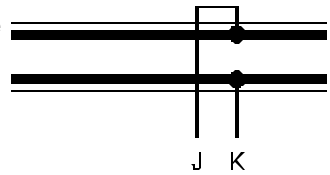
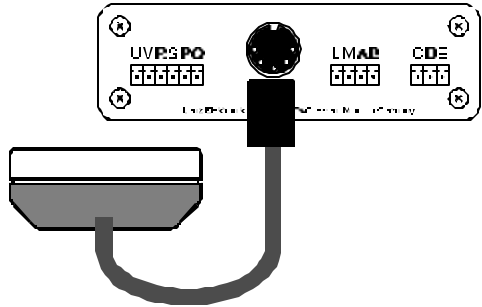

3. For a quick start, connect terminals U and V of the LZ100 and of the LV101 to a model railway transformer with a 14-18 VAC voltage. Eventually you will want **two** separate transformers but for now a single transformer will work fine. For initial operation virtually any transformer with a current rating of greater than 13 VA will work. To operate the maximum number of locomotives a transformer with a minimum capacity of 60 VA should be used for the LV101 and a 1.25 Amp 14 volt transformer such as the TR16 used for the LZ100. See page 82 for more details on suitable transformers.

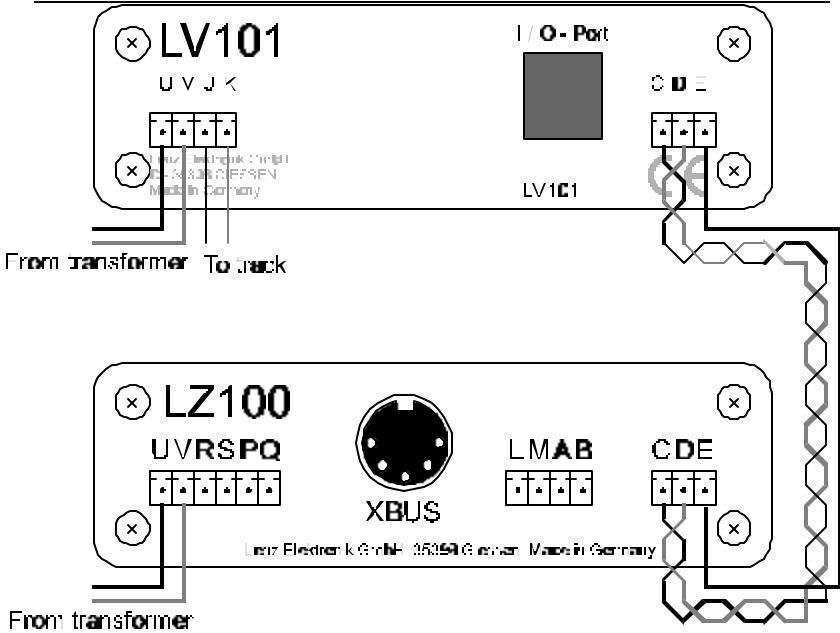

4. Connect the LZ100 and the LV101 by installing a wire between the **C** connection on the LZ100 to the **C** connection on the LV101. Install a second wire between the **D** connection on the LZ100 to the **D** connector on the LV101.
5. Put the locomotive which is equipped with the locomotive decoder onto the track. (refer to the instructions that came with the decoder for installation instructions)
6. Plug the power cord of the transformer into a wall socket. The display on the LH100 lights up and the red led's on the LZ100 and LV101 turns on solid red.

You can now start operating trains!
(Yes, already!)

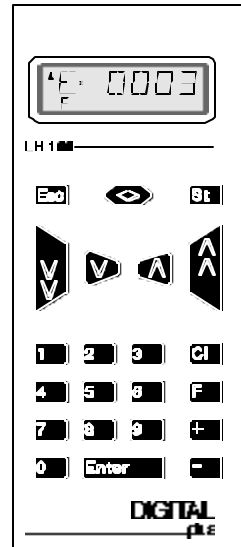





3.2 Operating Your first Train

For this example we will assume that you are using a locomotive with the address 3.

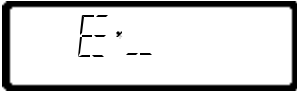
3.2.1 Selecting the locomotive address:

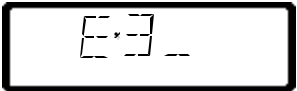
To operate a locomotive you must first enter the address of the locomotive into the LH100:

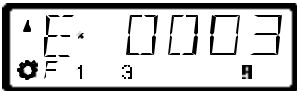

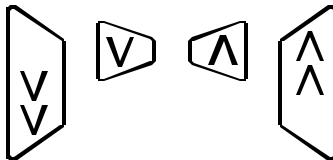

Press	On the display you see	Explanation
		First clear the display, and begin entering the address
		The number keyed in is displayed. If you keyed in the wrong number, you can clear the last entered digit with 'CL'. You do not need to enter leading 0s of an address
		You end the data entry with 'Enter'. The direction of travel and the status of the functions for this particular locomotive will now be displayed. In this example the direction of travel is forward (arrow on left points up), the functions 0 (light symbol), F1, F3 and F8 are activated.

3.2.2 Controlling the locomotive's speed:

The speed of travel of the locomotive is controlled with any one of the four following *operation keys*.







If you press any one of these keys and keep it pressed, the speed will automatically be increased (or decreased) until the maximum upper speed limit (or speed step 0) is reached.

Key	Explanation	Key	Explanation
	Each time you press this key, you decrease (or slow down) the speed of the locomotive by 1 step until the locomotive is stopped		Each time you press this key, you increase (or speed up) the speed of the locomotive by 1 step until the maximum speed is reached.
	Each time you press this key, you decrease (or slow down) the speed of the locomotive by 5 steps in 14 throttle notch mode, 8 steps in 27 or 28 throttle notch modes, or 16 steps in 128 throttle notch mode. The locomotive will slow down at its programmed deceleration rate		Each time you press this key, you increase (or speed up) the speed of the locomotive by 5 steps in 14 throttle notch mode, 8 steps in 27 or 28 throttle notch modes, or 16 steps in 128 throttle notch mode. The locomotive will speed up at its programmed acceleration rate

Pressing any of these keys will also cause the display to automatically change from showing the locomotive address to showing the locomotives current speed.

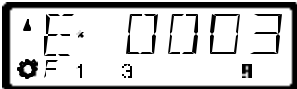

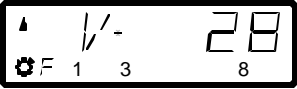

Each time you change the locomotive's speed, the display will automatically change from showing the locomotive's address to showing the locomotive's speed and direction. If speed step 0 (locomotive standing still) is reached, the display will automatically change back from showing speed steps to showing the locomotive address.

You can also toggle back and forth between displaying the locomotive's speed and the locomotive's address using the 'Enter' key.

Press	On the display you see	Explanation
	If the locomotive address is shown, you can use the 'Enter' key to change to showing the speed steps.	
		This does not change the speed or direction of the locomotive.
		When showing the locomotive's speed, pressing the 'enter' key will again change to showing the locomotive's address.

3.2.3 Changing the locomotive's direction of travel:

To change the locomotives direction of travel, first set the speed to "0". Then you can change the direction of travel:

Key	Display	Explanation
		Each pressing of this key changes the direction of travel of the locomotive. The changed direction will be shown in the display.
		When the arrow is up the locomotive goes forward. When the locomotive points down the locomotive will operate in reverse.

The direction of travel is tied to each locomotive, for example: with a steam engine, forward means "smokestack forward", regardless of in what direction you have placed this locomotive on the track.

If the locomotive has speed step 00, each pressing of the '<>' key will change the direction of travel.

The '<>' key also has another function: It affects an emergency stop for the specific locomotive contained in the display.

If the locomotive is operating at a speed step greater than 00, pressing the '<>' key once will cause the locomotive being controlled to immediately stop without any pre-programmed deceleration. Only by pressing the '<>' key a second time will change the direction of travel, which is shown in the display by an arrow in the upper right hand of the display that points up (forward) or down (backwards).

3.2.4 Emergency stop/Emergency off:

With the  key you cause an emergency stop for the entire layout. When this key is pressed, all locomotives will immediately stop. By pressing this key again, the emergency stop is released. This operation of this key can be configured using the set command. (⇒p. 28)

At this point you have very quickly learned how to operate a locomotive with the LH100 throttle.

There are many more advanced capabilities that the LH100 provides. These features are described in the following sections. It is not important that you know how to use all these advanced features. You can learn to use them at any time in the future when you have a

need.

4 System design overview of DIGITAL plus

DIGITAL plus is a digital multi-train control system for all model railroad scales. It was developed in close co-operation with model railroaders. Figure 1 shows the simple and clear system design of DIGITAL plus.

DIGITAL plus is compatible with NMRA-DCC systems and their locomotive and accessory decoders. It is also compatible with all **XpressNet** certified handheld or other system devices. If you have an older NMRA DCC system, you can use this older system as a handheld using the Translation Module LC100.

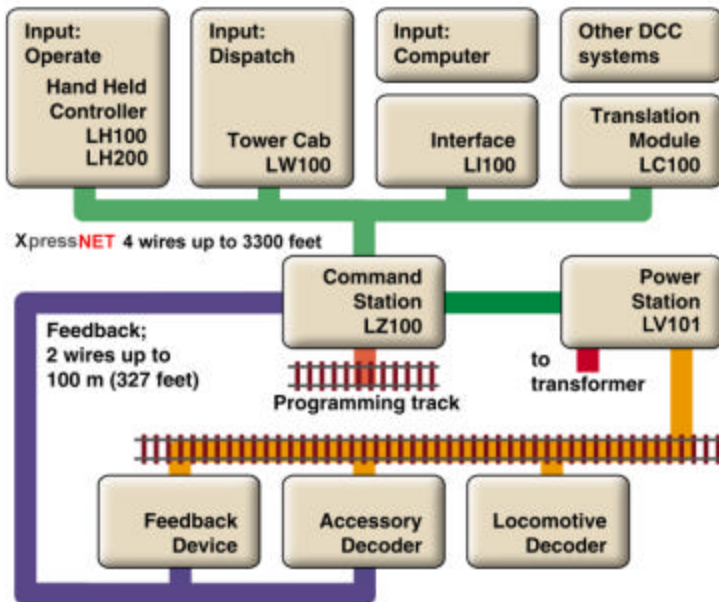

Figure 1: DIGITAL plus System Overview

The capabilities of DIGITAL plus are to a large extent determined by a program running inside the unit, the software. Version 3.0 is our 4th major system release.

The advantage of this approach is that new functions can be adopted simply by changing the software. It is not necessary to purchase new units. This way it is easier to implement suggestions for improvements from model railroaders.

4.1 Command Station LZ100

The core of the system is Command Station LZ100. It co-ordinates the input devices (Hand Held Controller LH100, etc.) and is also responsible for data processing. Information is exchanged between Command Station and input devices via a 4-wire cable, called **XpressNet**. The Command Station generates the control signals for Power Station LV101, which combines them with the necessary power and sends them to locomotive and accessory decoders.

The Command Station has no boosted output to connect to tracks. Accordingly it only needs a small transformer 14V AC (15VA), which could be one you already have from a starter set or supplied as part number TR16.

4.2 Installing the Command Station

Command Station LZ100 is connected to the AC output of the transformer with 2 wires at terminals **U** and **V** (see Figure 2). For long term operation you need a separate transformer such as the TR16.

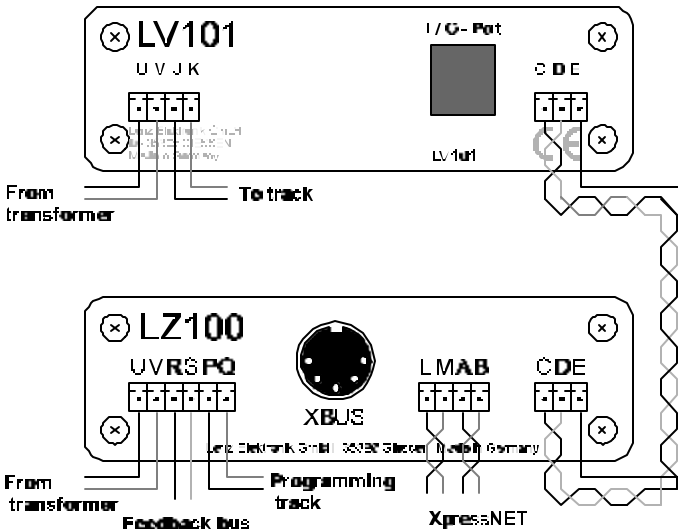
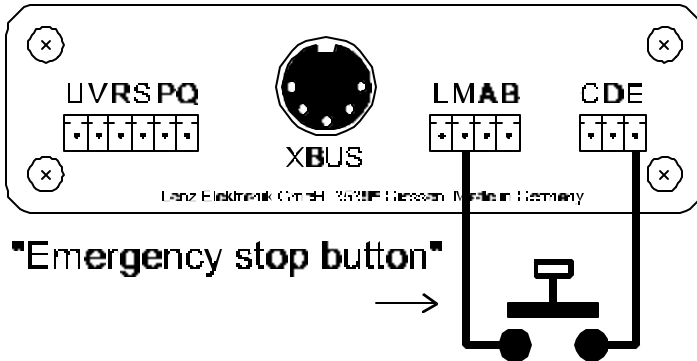

Figure 2: Complete Connections of Command Station and Power Station

Connect the programming track to terminals **P** and **Q**. This track must be completely isolated from the rest of the layout.

Terminals **C** and **D** transmit the data signal needed by the Power Station. These terminals are connected with the corresponding terminals on the Power Station with a twisted pair wire (see Figure 2). You can easily make a twisted pair wire from two normal single wires that you twist together.

The terminal **E** connection between the LZ100 and the LV101 is optional. If terminal **E** on the Command Station is connected to terminal **E** on the Power Station, the Power Station is able to provide feedback about overloads. The Command Station will then turn off all other Power Stations and send the corresponding information to Hand Held Controllers and other input devices. You can also use a pushbutton to connect terminal **E** to connection **M**. This allows the push button to be used as a layout emergency stop.



The **feedback bus** is connected at terminals **R** and **S**. Via this wire, which also must be a twisted pair, the Command Station asks for the state of for example turnouts or track occupancy detectors. For this purpose, feedback units are connected to this (Accessory Decoder with Feedback LS100 or Feedback Encoder LR101). For more details on connecting these units, please refer to the respective manuals.

If the Command Station is correctly installed and wired, and the supply power of the transformer switched on, the LED on the front of the Command Station lights up. If the LED flashes after the power up, then there is a wiring problem on the **XpressNet**.

5 Overview of the functions of LH100

This section will provide you:

- a short overview of each of the functions of LH100.

Specific details for using each feature follows in subsequent subsections, which follow this section.

5.1 Controlling locomotives

5.1.1 Selecting locomotive addresses

There are 3 different ways to select a locomotive address. Up to 9999 addresses for digital locomotives are available to you. With address 0 you control a conventional locomotive in the digital operation. More about entering and selecting locomotive addresses can be found in the section "*Entering a new locomotive address on the LH100 keypad*" starting on page (⇒p.20).

5.1.2 Changing speed and direction of travel

You change the speed and the direction of travel of the locomotive with specially shaped keys described in the section "*Changing locomotive speed and direction*" starting on page (⇒p.20).

5.1.3 Emergency stop

With the emergency stop you bring one or all locomotives to an immediate stop described in the section "*Emergency stop and emergency off*" starting on page (⇒p.28).

5.1.4 Turning locomotive functions on and off

You can access up to 13 functions in each locomotive decoder.

You can also determine if the function operates as a on/off or momentary function. How you control locomotive functions is described in the section "*Activating locomotive functions*" starting on page (⇒p.24).

5.1.5 Setting the Throttle-notches for a particular locomotive

With the LH100 you can select 14, 27, 28 or 128 Throttle-notches for the currently selected locomotive address. (Depending on the software version of the command station you are using). This information is stored in the command station for subsequent use.



How you select the different Throttle-notches and match it to your locomotive decoder is shown in section "*Showing and changing throttle-notches*" starting on page (⇒p. 26).

5.2 The function menu of LH100

The LH100 function menu provides you access to all other functions of the LH100.

The different menu items can be reached in 2 different ways when you are in the locomotive control mode:

Option 1:

Press  and scroll through the menus with  until you reach the desired menu

Option 2 (Quick access):

Press  and then the number of the desired function. The corresponding numbers can be found in the detailed description of each function.

Following is a brief description of each of the individual LH100 menu items.

5.2.1 Setting locomotive decoder functions to on/off or momentary function

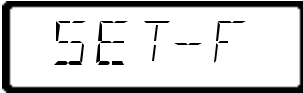

Each individual function between F1 and F12 can be configured on a per locomotive basis to either be *on/off* or *momentary*. In *on/off operation* the function is turned on with one keystroke and turned off with the next keystroke. In *momentary operation* the function is only turned on for as long as you keep the corresponding key pressed. When you release the key again, the corresponding function turns off again.

The procedure for setting this is described in "*Configuring locomotive decoder functions*" starting on page (⇒p.30).

5.2.2 Double header

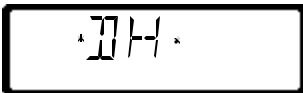

Double heading allows you to easily assign two locomotives to a double header and then operate it as a single locomotive from either locomotive address. The procedure for setting this is described in "*Double header*" starting on page (⇒p.32).

5.2.3 Multi-Unit Consist (MU)

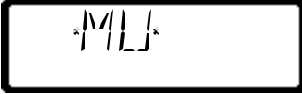

The LH100 implements smart consisting. Smart consisting allows you to set up a number of locomotives that can be operated as a single unit. As many as 256 locomotives can be controlled at the same time using a common consist address, which we call the locomotive's **multi-unit consist address (MU-address)**. To you it is as if you only controlled one single locomotive, but all the locomotives in the MU react at the same time.

With the LH100 you can (depending on the software version of the command station you are using) control, assemble and disassemble multi-unit consists.

Detailed information is found in "*Multi-unit consists (MU)*" starting on page (⇒p.37).

5.2.4 Throwing turnouts and setting signals

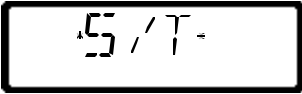

Using your LH100 you can throw turnouts, set signals or activate relays. To allow control via the LH100, these devices must be connected to accessory decoders LS100/110/120 of *Digital plus by Lenz*® system or other compatible modules. The procedure is controlling these devices using the LH100 is described in "*Throwing turnouts and setting signals*" starting on page (⇒p.43).

5.2.5 Display feedback information



The LH100 can also be used to display the status of the inputs generated by feedback encoders LR100/101. These feedback encoders can be used for example to display occupancy of selected locations of your layout.

You find the directions for displaying feedback information in "*Displaying feedback*" starting on page (⇒p.46).

5.2.6 Configuring decoder settings: Programming

Each decoder has settings that can be set to customize the decoder to an individual locomotive, for example the locomotive's address. The user-settable acceleration and deceleration delays are also configurable settings on a locomotive decoder. These settings can be changed by a technique we refer to as programming. The LH100 provides two programming methods. Which method you can use depends on your command station and its software version, as well as the locomotive decoders you use.

5.2.7 Operations mode programming

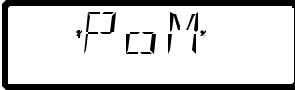

Using operations mode programming or "Programming on the main", you can configure the settings of your locomotive decoder while the locomotive is being operated anywhere on the layout. For example, couple your locomotive in front of a heavy freight train and now adjust the acceleration delay to fit the train! Operations mode Programming is described in "*Programming on the Main (POM)*" starting on page (⇒p.50).

5.2.8 Programming on the programming track



Using a separate programming track you can both configure and read back each of the individual locomotive decoder's settings. Information on programming using a programming track can be found in "*Programming on the programming track*" on page (⇒p.54).

5.2.9 System settings



The LH100 allows you to configure several system settings. For example, you can program how the emergency stop button works, check and change the LH100 XpressNet address, read out the software version of your command station, and more. Detailed descriptions can be found in "*Configuring the LH100 handheld using the SYS menu*" starting on page (⇒p.66).

6 The LH100 LCD Display

In this section you will learn about the LH100 two-row LCD display.

The upper row shows you the address of a single locomotive (E), a locomotive in a multi-unit (ash-up) (m), a double header (C) or a multi-unit consist (M) or the speed step (V).

The arrow shows you the direction of travel of the locomotive, multiple unit consist or double header. Arrow pointing upwards indicates forward. Arrow pointing downwards indicates reverse.

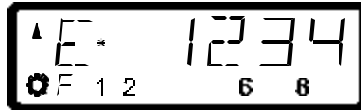

The lamp symbol shows you if function 0 is turned on or not (Not displayed when controlling a consist).

The numbers indicate which functions are turned on or off. In the example functions 1, 2, 6 and 8 are turned on. (Not displayed when controlling a consist.)

Depending on which mode of operation you are using, the display will look different. The display for the locomotive address always uses 4 digits. Zeros are added in front of the address if needed.

Here are examples of the most important displays:



A single locomotive with address 0003 is being controlled.

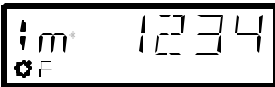

A locomotive with address 1234 is in a multi-unit consist.



A multi-unit consist with address 33 is being controlled.

Examples for the display of speed steps:



Speed step 1 in "28 speed steps" mode

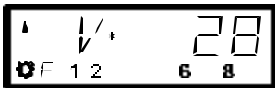

Speed step 28 in "28 speed steps" mode

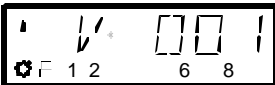

Speed step 1 in "128 speed steps" mode

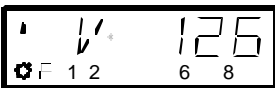

Speed step 126 is the maximum speed in "128 speed steps" mode

While the speed step is displayed, the locomotive address is hidden. The direction of travel and the functions continue to be displayed.

7 Controlling locomotives with the LH100

In this section you will learn about basic locomotive control using the LH 100. When you want to control a locomotive, you have to *call it up* first. There are three different ways you can call up a locomotive you want to control:

- Enter the number of the locomotive on the LH100 keypad
- Toggle between 2 locomotive addresses
- Seek out a locomotive from the command station stack.

All addresses from 0 to 9999 are valid. Address 0 is intended for conventional locomotives (ones without a digital decoder).







When you first start using the LH100, it displays locomotive address 0003.

7.1 Changing locomotive speed and direction

How to control a locomotive's speed and direction of travel was already described in the section "*First Steps: Controlling locomotives*". Please refer back to this section on how to control the speed and direction of your locomotive.

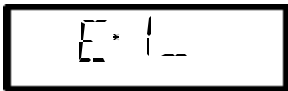
7.2 Entering a new locomotive address on the LH100 keypad

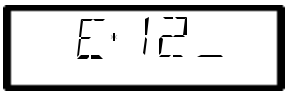
In the following example a locomotive address "1234" is entered using the LH100 keypad.

Press	On the display you see	Explanation
		Clear the display first.
		Begin to enter the address by pressing the first digit of the locomotive's address on the keypad.
		If you make an error, you can use  to erase the last entered digit.

3	E·123_	You continue by pressing each number in the locomotive's address
4	E·1234	
Enter	▲E· 1234 ●F	The information about functions, direction and speed step associated with this address will now be displayed.

If the display flashes after you call up a locomotive address, then the locomotive is already being operated by another hand held controller/ If you desire you can still take over control of this locomotive. More about this in "*Taking over control of a locomotive from another hand held controller*" starting on page (⇒p.24).

7.3 Quickly toggling between 2 locomotive addresses

The 'Esc' key on the LH100 keypad can be used to toggle between the two locomotive addresses.

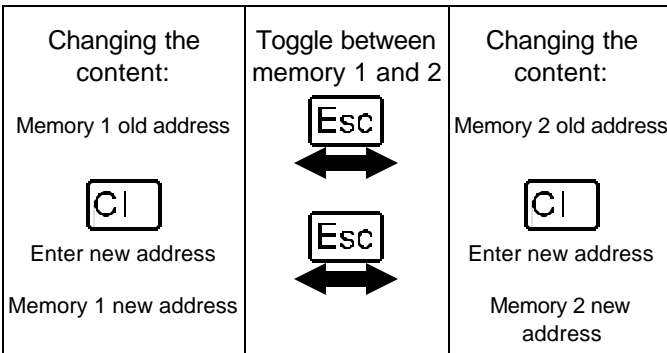











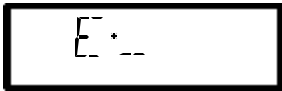

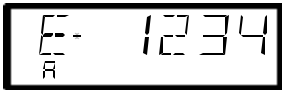
For example: You have just called up locomotive 24. The address for that locomotive is now in one of the two LH100 locomotive memories.

Now press the 'Esc' key, and the display will change to the address that is in the second memory. This is for instance address 22. If you now want to operate a locomotive with the address 78, then press 'C|', enter the address 78 and confirm with the 'Enter'

key. From now on, you can use the 'Esc' key to toggle between address 24 and 78. If you press the 'Cl' key, then the locomotive address in the memory currently shown is erased; the locomotive address in the second memory is still available for use.

7.4 Selecting an address from the command station stack

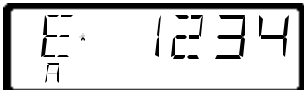
The command station stack is a database that contains all the locomotive addresses that have been used together with the locomotive's associated data (speed step, function status). With this function you can select an address to control from any of the addresses the database:

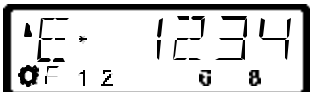
Press	On the display you see	Explanation
		First clear the display
		The first locomotive from the command station stack is displayed. The "A" in the lower row shows that you are in the selection from the locomotive stack.
		Each pressing of the '-' key pages through the locomotive stack in the command station. The two first examples show single locomotive addresses.
		This is an example of a locomotive address that is part of a multi-unit consist.
		Here is a multi-unit consist address displayed for selection.
		Keep paging until you see the locomotive address you want displayed.
		Using 'Enter' you can now select the address of the locomotive you want to control. Direction and function status are now displayed.

You can also clear a locomotive from the command station stack, if this option is set in the system settings. For more information see section "*SET_5: Erasing locomotive addresses from the command station stack*" starting on page (⇒p.71).

7.5 Taking over control of a locomotive from another hand held controller

When desired you will take over control of a locomotive that is being operated by another engineer. To do this you call up the locomotive's address. The locomotive's information is now shown flashing. If you don't want to take over control of the locomotive, but want to find out the current operational data for the locomotive, then each pressing the 'Enter' key will update the operational data of the locomotive in your display. If for instance the speed step of the locomotive is changed on the first hand held controller, you can observe that on your hand held controller's display.

You take over control for this locomotive from the other handheld to your hand held controller by pressing one of the following keys:

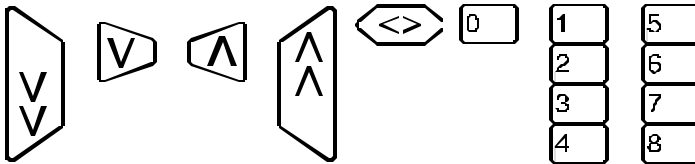





The display no longer flashes, and on the display the newest operation and function data is shown. Now the display on the other hand held controller flashes. Only the next operation command (pressing one of the keys shown above) will be sent to the locomotive, which prevents unintended sudden changes of the speed.



7.6 Activating locomotive functions

All *Digital plus by Lenz*® locomotive decoders have one or more additional functions. The functions are numbered, beginning with 0. Altogether the *Digital plus by Lenz*® system can reach up to 13 functions in locomotive decoders.

Functions 0-8 can be activated directly while you are controlling a locomotive (that is the locomotive address or the speed step is displayed), using keys the '0' to '8':

Press	On the display you see	Explanation
		
0		This function 0 is assigned to the headlights in most locomotive decoders and is shown by the lamp symbol in the lower row of the display.
2		The state of functions 1 to 8 is shown in the second row next to the "F".
8		If the functions are set to on/off mode (factory default), then the first key stroke turns on the function.
8		The next keystroke turns the function off again.
		If the function is set to momentary activation, then it is only turned on for as long as the key is pressed. The display shows accordingly.

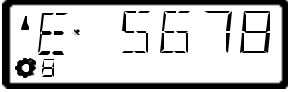
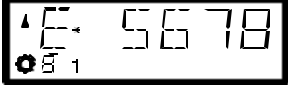
To turn functions 9 to 12 on and off, you must first switch the display over to the high order function block using the '9' key:

9		The "F" in the lower row changes to a slowly flashing "8".
1		The '1' key now turns on function 9, the '2' key function 10 and so on. You must simply add the number 8 to the displayed function (flashing display) .
9		To return to functions 1 to 8, again press the '9' key.

By pressing one of the keys that turn functions on or off, you are also asking the DCC command station to send the locomotive an instruction to activate or turn off that specific function.









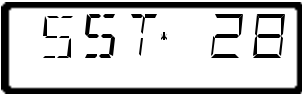

7.7 Showing and changing throttle-notches

In this section you learn:

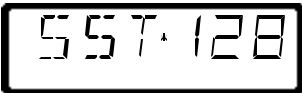
- what throttle-notches are
- which throttle-notches are available to you
- how to select different throttle-notches for individual locomotive addresses.

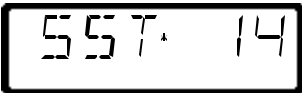
The area from stopped to maximum speed of a locomotive is divided into a series of throttle-notches. The more notches present, the smaller the division between different locomotive speeds. With the LH100 you can set the displayed locomotive address to have 14, 27, 28 or 128 throttle-notches.

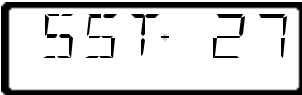
This is how you show/change the speed step modes:

Press	On the display you see	Explanation
		Call up the locomotive address whose number of throttle-notches you want to see or change. Make sure that the locomotive is on speed 0; if needed press the '<>' key.
		After pressing the '+' key the current number of LH100 throttle-notches is shown. 28 throttle-notches is the default for version 3.0
		By repeated pressing of the '+' key you are now shown the possible throttle-notches that are available.
		
		
		To assign a desired number of throttle-notches to this locomotive address, press 'Enter'.

 If the locomotive's speed is not 0, then the currently set number of throttle notches is shown as long as you keep the '+' key pressed, but the mode cannot be changed.

☞ For locomotive addresses 100-9999, only 28 and 128-throttle-notches are available for use.

☞ The locomotive decoder's speed step mode (set via CV29) must match the LH100 number of throttle-positions (⇒p.47).

The following correspondence between system and locomotive decoder must be created:

System	Locomotive decoder
14 or 27 throttle-positions:	14 speed steps
28 or 128 throttle-positions:	28 speed steps

Setting the locomotive decoder to a particular speed step mode is done in CV29 of the decoder. For details, see the *Digital plus by Lenz*® "Information for locomotive decoders".

You must make sure that the locomotive decoder also "understands" the programmed speed step mode. For Digital plus decoders the following correspondence applies:

DIGITAL plus locomotive decoder types	supported speed step modes
NMRA- XF or XS-series conforming decoders	14, 27, 28, 128
Other NMRA- conforming decoders	14, 27, 28
all other DIGITAL plus decoders	14, 27

If unsure, please check in the decoder's operation manual. NMRA-conforming *Digital plus by Lenz*® decoders can be recognized by the following symbols on the title page of the operation manuals:



8 Emergency stop and emergency off

In this section you will learn about:

- the function of the **St** key.
- how to turn off track power
- changing information during an emergency stop

The 'St' key tells the system to perform an emergency stop. You can program this key to have two different effects:

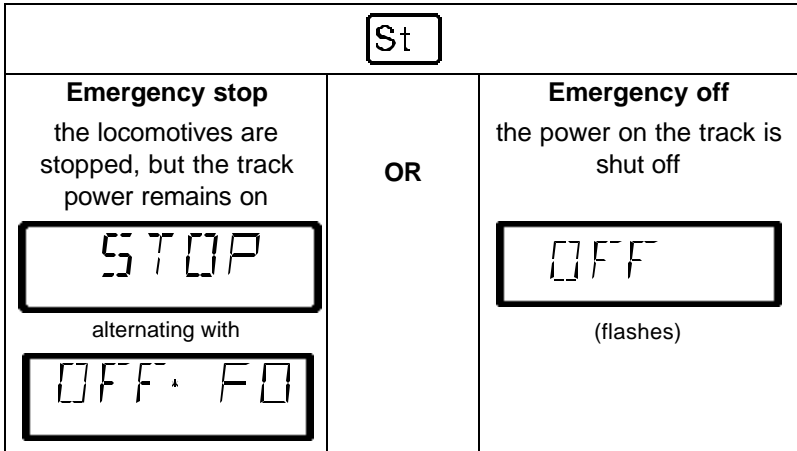

The factory default is emergency stop, that is all the locomotives are stopped with track power remaining on. How you program the 'St' key is described in section "".

8.1 Turning off the track power

If an emergency stop has been triggered, you can still turn off the power to the track:

Press	On the display you see	Explanation
		Call up the locomotive address whose function setting you want to display or change
St	<div style="border: 2px solid black; padding: 5px; text-align: center; font-family: monospace; font-size: 1.2em; margin: 5px 0;">STOP</div> <p style="text-align: center; font-size: 0.8em;">alternates with</p> <div style="border: 2px solid black; padding: 5px; text-align: center; font-family: monospace; font-size: 1.2em; margin: 5px 0;">OFF FO</div>	The emergency stop is displayed.
		The display "OFF FO" is designed to remind you of the key stroke sequence needed to turn off the track power:

F	F _ _	You start the power off sequence by first pressing the 'F' key.
0	OFF	Next you press the '0' key. The track power is now turned off
(flashes)		
St	▲ E 0003 ⚙ F 1 3 8	Pressing the 'St' key a second time resets the emergency stop, the track power is turned on again.

8.2 Changing operating information during emergency stop/off

During the emergency stop/emergency off you can change the operating information that will be sent to the locomotives on the layout once you resume operation. This allows you to fix the problem that caused you to emergency stop the layout before you resume operation.





Press	On the display you see	Explanation
	STOP	The emergency stop or emergency off is displayed
alternates with		
	OFF FO	
Esc	▲ E 0003 ⚙ F 1 3 8	You return to controlling locomotives with 'Esc'. You can now change the speed and direction that the displayed locomotive resume with when the layout is turned on again...

You can also call up other locomotives and change their speed and direction. all the changes made will take effect once you resume operation by pressing the 'St' key a second time.

When in this mode the "E" in the display will blink

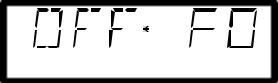
8.3 Switching turnouts during emergency stop

Since the track power remains on during the emergency stop, you can continue to switch turnouts and signals:

Press	On the display you see	Explanation
		The emergency stop or emergency off is displayed
	alternates with	
		
		You return to controlling locomotives with 'Esc'.
	The last chosen function menu is displayed	You can now change into the mode for switching turnouts and signals.







When you have switched the turnouts and signals, you use 'Esc' to return to the emergency stop display.

9 Configuring locomotive decoder functions

In this section you learn:

- how to configure the operation of individual locomotive functions.

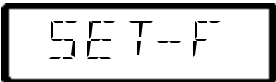
You reach this function menu in one of two ways

 followed by 	OR	 then scroll through the menus using  or 	
		until you see a display of  then press 	

In the section “*Activating locomotive functions*” it was noted that locomotive decoder F1 to F12 can be set to operate as on/off as well as in momentary on operation.









The system default is on/off meaning that the function is turned on with one keystroke, and turned off again with the next keystroke. In momentary operation the function is only turned on for as long as

the corresponding key is pressed. When you release the key, the function being controlled is turned off again.









This setting is stored in the LZ100 command station. The LH100 hand held controller will check these settings each time a locomotive is called up. You can configure this setting for each function and each locomotive address individually.

All function menus are reached through the 'F' key and subsequent paging with the '+' or '-' key.

Proceed as follows:

Press	On the display you see	Explanation
	Call up the locomotive address whose function setting you want to display or change.	
	The most recently selected menu is displayed	
		The digits in the lower row show which functions are set to on/off operation and which are set to momentary operation. In the example shown functions 1, 2, 3 and 5, 6 and 8 are displayed which means the function is on/off. This also means that functions 4 and 7 are set to momentary operation. If you want to change this setting, then simply press the key corresponding to the function.
		By pressing key '5' the number "5" is no longer lit. Function 5 is now set to momentary operation.
		Close the input with the 'Enter' key. The new setting is stored in the command station. 'Esc' will take you back to controlling locomotives without storing and changed information.

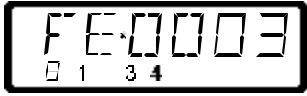

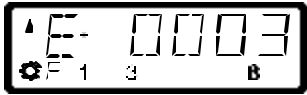



When you want to change the settings for functions 9 to 12, then proceed as follows:

Press	On the display you see	Explanation
		Call up the locomotive address whose function setting you want to display or change.
		Go to setting the functions
		Pressing '9' will switch over to showing the status of functions 9 to 12. Just as when activating the functions, you will see a flashing "8".
		Displaying and changing the setting takes place as described above. In this example function 10 was changed to momentary operation.
		'Enter' stores the changes, with 'Esc' you return to controlling locomotives without storing anything.

10 Double header

In this section you learn:

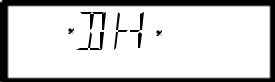
- how to configure and operate two locomotives as a double header
- how to combine two locomotives with different speed steps into a double header
- error messages you might get when attempting to create a double header
- how to disassemble a double header

You reach this function menu in one of two ways		
	OR	 then scroll through the menus using  or 
followed by		
		until you see a display of  then press 

The LH100 allows you to assign two locomotives to operate together as a double header, and then control them as if they were a single locomotive.

10.1 Prerequisites for creating a double header

- You must have called up on the same hand held controller each of the two locomotives that you want to put together as a double header.
- You must have given each locomotive a command (that is changing speed, direction or turning on or off one of the functions)
- The speed step of both locomotives must be 0 when they are put together.

 You cannot include a non DCC locomotive (address 0) in a double header! If you attempt to do this you will get an error message.

10.2 Configuring two locomotives as a double header:

First call up the first locomotive (for instance locomotive 24), and move it to the location of your layout where you want to couple it together with the second locomotive.











Then call up the second locomotive (for instance locomotive 78), and move it up next to the first locomotive.

In this manner you make sure that you have both locomotives called up on your hand held controller and that you also have given each of them an operating command.

Make sure that both locomotives are set to operate in the same direction.

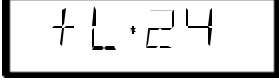
It is of course possible that the direction arrow for one locomotive points up and the direction arrow of the other locomotive points down, since the direction of travel is locomotive dependent.

Proceed as follows:

Press	On the display you see	Explanation
	The most recently chosen menu is shown	
		The most recently selected locomotive address is displayed
		This is the prompt to enter the second locomotive address of the double header.
		Enter the number of the second locomotive. If you make a mistake when entering, you can clear the entry with 'Cl' and correct it.
		
		'Enter' combines both locomotives to a double header and returns you to the operation display

Controlling a double header is shown in the display with a "D" instead of the "E". Behind it is the address of the locomotive that was the first to be added into the double header. Direction arrow and display of functions are the same as when you control a single locomotive.

You can now control the double header you constructed from either locomotive address just like you would a single locomotive with the operation keys. When you do so the two locomotives will be sent the corresponding operation command directly after each other.

When running a double header the *operation keys* (raise and lower speed steps, direction change) *work on both locomotives* at the same time. The keys that turn functions on and off *work only on the locomotive* whose address is shown in the display.

If you want to change a function on the second locomotive operating in the double header, then you must call up this locomotive. Now you can turn a function on or off on this locomotive.

If while operating a double header you want to check what other locomotive belongs to the double header in addition to the locomotive address shown, then press the '-' key. While you keep this key pressed, the address of the second locomotive in the double header will be shown in the display, even when the speed step of the double header was shown at the moment.

10.3 Combining locomotives with different speed step numbers into a double header

You can combine locomotives with different speed steps into a double header. The speed step corresponding to the speed step of the individual locomotive will always be shown.

Example:

The locomotive with address 24 has 14 speed steps, the locomotive with address 78 has 28 speed steps. If you now see the maximum speed step 14 when showing locomotive address 24, then after you switch over to locomotive address 78 you will see speed step 28, since that is the maximum speed step for locomotive 78.

10.4 Error messages when assembling a double header





If you made an error when assembling the double header, you will see one of the following messages in the display:

ERR 24	The locomotive was not selected or no command to the locomotive was sent prior to setting up the MU/double header.
ERR 25	One of the locomotives of the MU/double header is being operated on another Handheld.
ERR 26	One of the locomotives is already part of another MU/double header.
ERR 27	One of the two locomotives was not at throttle position 0. Locomotives must be stopped before you can combine them into a consist.

Press the 'CI' key to clear the error message from the display and return to locomotive control.

10.5 Disassembling a double header

Go through the following steps:

Press	On the display you see	Explanation
		Call up one of the two locomotives that are assembled into a double header on your hand held controller.
F	The display shows the most recently chosen menu	
2		When you want to disassemble the double header press the '2' key,
-		This display flashes. If you want to disassemble the double header, then press 'Enter', if not, press 'Esc'.
Enter		The double header was disassembled.

You can use the 'Esc' key to interrupt the disassembling of the double header at any time in this process before you press the final 'Enter' key.

If the double header is disassembled, the display will again show an "E" in front of the locomotive address.

 You can disassemble a double header even when the speed of the locomotive is not currently 0!

11 Multi-unit consists (MU)

In this section you find out:

- what a multi-unit consist is
- how a multi-unit consist is assembled and disassembled
- how you control the functions on locomotives in a multi-unit consist

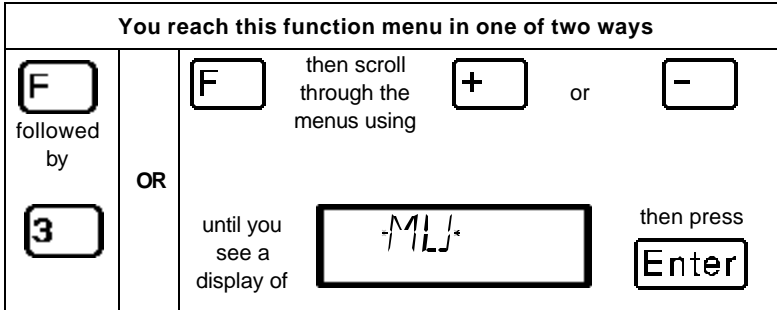

 The multi-unit consist function requires a command station LZ100 of version 3 or higher, or a SET02/03 (hand held controller LH200 is command station) The multi-unit consist menu is not available when connecting an LH100 to a command station with software prior to version 3.

 When using SET02/03 you can only assemble and disassemble multi-unit consists from the LH200 that is functioning as the command station. All other functions relating to a multi-unit consist, such as controlling, switching functions of the locomotives in the MU consist are available from the LH100.

11.1 What is a multi-unit consist?

In a multi-unit consist several locomotives are controlled with one common address, the **multi-unit consist address**, all at the same time. This multi-unit consist address must always be two digits (1-99). The LH100 implements what we call *Smart Consisting*. In *Smart Consisting* you can control the MU's speed and direction from any locomotive's address that is within the consist.

When assembling the MU each locomotive in the MU is notified of the multi-unit consist address. This address is stored in the locomotive decoder as a second address. From now on, the

locomotives will not “listen” to their own address, but instead will respond to speed and direction commands only sent to the multi-unit consist address. But don’t fear: The locomotive decoder will not forget its own address, it remains stored for later use.

Speed and direction of a MU will be controlled using the multi-unit consist address. If a locomotive that is assembled into a MU has switchable functions (light, smoke generator), you can continue to control these functions via the locomotive’s normal address.

When you disassemble the MU, the multi-unit consist address in the locomotive decoder is erased, and the locomotive immediately responds to its own address again.



All locomotives that you want to use in assembling or disassembling a MU must be on the layout! That’s the only way the special MU commands that are sent over the track can also reach the locomotive decoder! This is especially important when you want to remove a locomotive from the multi-unit consist: If the disassemble command doesn’t reach the locomotive decoder (due to bad contact or because you removed the locomotive from the track), then the MU address in the locomotive decoder will not be erased, and the locomotive can’t be run on its own normal address.

11.2 Prerequisites for a multi-unit consist:

You can set up multi-unit consists with any NMRA conformant locomotive decoders from the *Digital plus by Lenz*® program. **The locomotive decoder must be configured for operation with 28 speed steps.**

11.3 Assembling a multi-unit consist (MU)

Drive all the locomotives that you want to assemble into the MU to the location on your layout where you want to start controlling the MU.

It does not matter which direction the locomotives were operated before assembling them into the MU as you will be asked the direction for each locomotive you add to the MU. This allows you to construct MUs with locomotives head to tail or elephant style.

Begin assembling the MU:

Press	On the display you see	Explanation
		Call up the first of the locomotives that you want to include in a MU.
	Display shows the most recently selected menu	
		You see the prompt for entering the multi-unit consist address
		Key in the number of the MU. This number can only have two digits.
		If you make a mistake, then you can clear the last digit with the 'C' key and make corrections.
		The direction arrow now blinks. At this point you decide which direction the locomotive will enter relative to the consist direction.
		Pressing the '<' key will change the blinking arrow to point down. This means that the locomotive will enter the consist in the reverse direction. Moving the consist forward will cause the locomotive to move backwards.
		Pressing the '>' key again causes the blinking direction arrow to now point up or forwards. The locomotive will now enter the consist moving in the same direction as the consist.
		The "E" in the display now changes to a small "m" to show you that this locomotive is in a MU

Now call up the next locomotive that you want to include in the MU and repeat the steps that you already made to include the first locomotive in the MU for this next locomotive.

Keep repeating this until you have included all the locomotives that you planned on in the MU. You can add or removes from the MU at any future time that you need to.

11.4 Controlling a multi-unit consist

To control a MU you call up either the MU address or one of the locomotives that are part of the MU.

The MU address itself is shown by a capital "M" in the display, a small "m" informs you that you this is a locomotive that has an address that is part of a MU.

11.4.1 Speed and direction of the MU

You can control the MU with the same keys you use for a "normal" locomotive from either the MU address or from any address from within the MU.

When controlling a multi-unit consist the *operation keys* (increase and decrease the speed step, changing the direction of travel) work *on all the locomotives in the MU* at the same time. Therefore it does not matter if the MU address (shown by a capital "M") or the address of a locomotive in the MU (shown by a small "m") is on display.

11.4.2 Controlling functions of a locomotive that is within a MU

The keys that turn *functions* on and off work *only on the locomotive included in the MU* whose address is shown in the display (shown by a small "m"). When the MU address ("M") is shown you can not switch any functions, and no function information is displayed.

If you want to change a function in a running locomotive included in the MU, then you have to call up this locomotive (see the next section). Now you can turn on or off any of the functions on this locomotive.

11.5 Displaying the members of a MU and switching between locomotives in a MU

You are always able to show the complete list of locomotives in the MU, as well as the MU address itself, at any time regardless of if you see the multi-unit address in the display (shown by a capital "M") or one of the locomotives in the MU (shown by a small "m"),

Press	On the display you see	Explanation
		Call up a locomotive in the MU or the MU address itself
-		Repeated pressing of the '-' key shows you all the addresses assembled in the MU and the MU address one after the other.
-		
Enter		You can select the currently displayed address for control by pressing 'Enter'. The functions and direction for this locomotive are now displayed

This “scrolling” through the MU is especially helpful when you quickly want to switch to a particular locomotive in the MU to turn functions on that locomotive on or off.

11.6 Removing a locomotive from a MU consist









You can at any time remove any individual locomotive that is part of a MU from the MU:

Press	On the display you see	Explanation
		Call up the address of the locomotive you want to remove from the MU
F	Display shows the most recently selected menu	
3		You are prompted to remove this address from the MU.
-		This display flashes. You now have the last opportunity to interrupt the removal with 'Esc'.
Enter		'Enter' removes the locomotive from the MU, and the display will then again show an 'L'.

When you remove the last locomotive that is in the MU from the MU, then the MU itself will be erased.

11.7 Erasing a completed MU

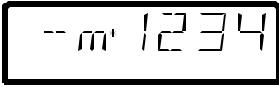
If you want to remove all the locomotives from a MU at one time then proceed as follows:

Press	On the display you see	Explanation
		First call up the MU address (shown by a capital "M").
	Display shows the most recently selected menu	
		You are prompted to erase this MU.
		This display flashes. You have the last opportunity to interrupt the erasing with 'Esc'.
	Flashes	
		'Enter' starts the disassembly.
		Each individual locomotive addresses in the MU is displayed and erased from the consist.
		Finally the consist address is shown as an individual locomotive address.

11.8 Error messages in multi-unit consists

If you made an error when assembling the multi-unit consist, you will see one of the following messages in the display:

ERR 24	The locomotive was not selected or no command to the locomotive was sent prior to setting up the MU/double header.
ERR 25	One of the locomotives of the MU/double header is being operated on another Handheld.
ERR 26	One of the locomotives is already part of another MU/double header.
ERR 27	One of the two locomotives was not at throttle position 0. Locomotives must be stopped before you can combine them into a consist.

Press the 'Cl' key to clear the error message from the display and return to locomotive control.

12 Throwing turnouts and setting signals





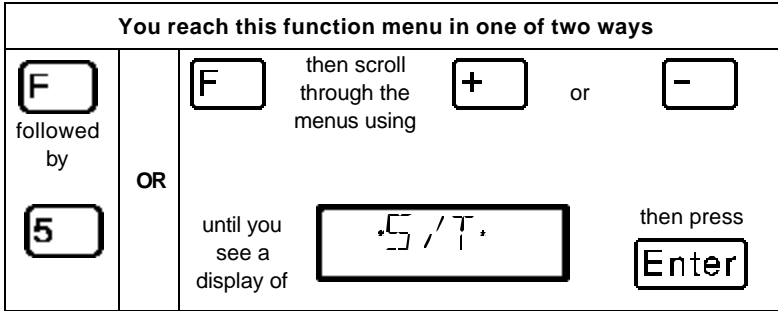





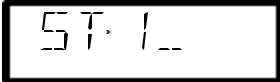

In this section you learn:

- how to control turnouts or signals

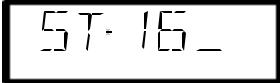

With the turnout control function you can use the hand held controller LH100 to throw turnouts, set signals or for instance activate relays. For this to work, these devices must be connected to accessory decoder LS100/110/120 of the *Digital plus by Lenz*® system or to other compatible NMRA DCC accessory decoders.

Proceed as follows:

Press	On the display you see	Explanation
	Display shows the most recently selected menu	
		Enter the number of the turnout (the magnetic device) that you want to actuate.
		If needed you can use the 'C' key to correct your entry
		The valid entry range is 1 to 1024. If you enter a lower or higher value, then you will again be prompted to enter a turnout address.
		Following the number (address) of the turnout will now appear a + or - to show the status of the turnout (or signal).
		Use the '+' or '-' keys to change the status of the turnout (or other device connected to the accessory decoder).
		The changed status is shown.

If you now want to throw another turnout, then press the 'C1' key and enter the new number of the turnout (or signal) that you now want to actuate.

12.1 Feedback and display of the turnout position

12.1.1 Using non-feedback capable accessory decoders

In this case the last command sent to the accessory decoder is shown on each LH100.

The display of the turnout position on the LH100 display changes automatically when the turnout position is changed by another LH100 (or another XpressNet device, for instance a tower cab).

12.1.2 Using feedback capable accessory decoders

When you are using the feedback capable accessory decoder LS100, and the feedback bus is connected to the LZ100, turnouts with end-of-stroke-off drives will show the actual turnout position as + or - whenever the turnout is called up.

Let's assume that turnout 18 has an end-of-stroke-off drive and is correctly connected to an accessory decoder LS100. Enter the number of the turnout (see above). The hand held controller gets a message from the command station that it is a feedback capable accessory decoder and now shows the following:

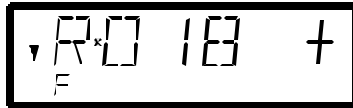

A 'R' on the left shows you that you have called up a turnout number of a feedback capable accessory decoder.

When calling up the turnout the position may be shown as for example +. If you now press the '-' key to throw the turnout, then the display will first change to '-'. If you press the '-' button and the turnout does not throw, you will see for a short moment '-' in the display, and this will become a '+' after you stop pressing the button. This way you can immediately see if a turnout has changed position or not. The display will also change when you throw the turnout by hand.

NOTE: Depending on the time that the turnout drive needs to reach its end of stroke, it may take a little while until the information in the display is correct.

For information on wiring the feedback bus please see the operation manuals for the feedback capable devices.

If the turnouts are not feedback capable, or connected to a non-feedback capable accessory decoder, then you can't have actual feedback of the turnout position. In this case you will see the last entered position (+ or -) when you call up the turnout. And when you press the + or - keys, the display will update immediately.

If after entering for instance the turnout address '118' you see this display

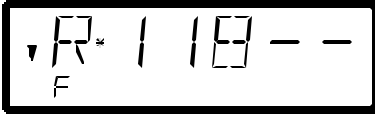

then this address is not an accessory decoder, but a feedback encoder LR100.

In this case pressing the '+' or '-' key will have no effect. Using the 'Cl' key you can get back to entering a new turnout address, using 'Esc' you can get back to controlling locomotives. Information about displaying the status on feedback encoders is in section "*Displaying feedback*" starting on page (⇒p.46).

12.2 Train operation while controlling turnouts or signals

While displaying a turnout address and its status, you can still use the operation keys to control the most recently called up locomotive.

When you press one of the operation keys, this locomotive address or speed is shown in the display. The turnout's address is shown when you stop pressing the key.

The locomotive's address' direction arrow and the status of the decoder functions are always shown in the display. This way you can still control the selected locomotive even while you throw turnouts and set signals. This allows you to comfortably execute yard switching operations.

13 Displaying feedback

In this section you learn:

- how to display layout feedback on the LH100 display

You reach this function menu in one of two ways

<div style="border: 1px solid black; padding: 5px; width: 40px; margin: 0 auto;">F</div> <p>followed by</p> <div style="border: 1px solid black; padding: 5px; width: 40px; margin: 0 auto;">6</div>	OR	<div style="border: 1px solid black; padding: 5px; width: 40px; margin: 0 auto;">F</div> <p>then scroll through the menus using</p> <div style="display: flex; justify-content: space-around; align-items: center;"> <div style="border: 1px solid black; padding: 5px; width: 30px; height: 30px; display: flex; align-items: center; justify-content: center;">+</div> or <div style="border: 1px solid black; padding: 5px; width: 30px; height: 30px; display: flex; align-items: center; justify-content: center;">-</div> </div> <p>until you see a display of</p> <div style="border: 1px solid black; padding: 5px; width: 150px; height: 30px; margin: 0 auto; display: flex; align-items: center; justify-content: center;"> 00 </div> <p>then press</p> <div style="border: 1px solid black; padding: 5px; width: 60px; height: 30px; margin: 0 auto; display: flex; align-items: center; justify-content: center;">Enter</div>
------------------------------------------------------------------------------------------------------------------------------------------------------------------------------------------------------	----	----------------------------------------------------------------------------------------------------------------------------------------------------------------------------------------------------------------------------------------------------------------------------------------------------------------------------------------------------------------------------------------------------------------------------------------------------------------------------------------------------------------------------------------------------------------------------------------------------------------------------------------------------------------------------------------------------------------------------------------------------------------------------------------------------------------------------------------------------------------------------------------------------------------------------------------------------------------------------------------------

Using this LH100 function you can show the status of any of the LR100/101 feedback encoders inputs.

Press	On the display you see	Explanation
<div style="border: 1px solid black; padding: 5px; width: 40px; margin: 0 auto;">F</div>	Display shows the most recently selected menu	
<div style="border: 1px solid black; padding: 5px; width: 40px; margin: 0 auto;">6</div>	<div style="border: 1px solid black; padding: 5px; width: 150px; height: 40px; margin: 0 auto; display: flex; align-items: center; justify-content: center;"> 00 - </div>	This is the prompt to enter the feedback encoder address
<div style="border: 1px solid black; padding: 5px; width: 40px; margin: 0 auto;">3</div>	<div style="border: 1px solid black; padding: 5px; width: 150px; height: 40px; margin: 0 auto; display: flex; align-items: center; justify-content: center;"> 00 * 3 - </div>	Let's assume that you want to show the 8 feedback inputs of feedback encoder address 39 on the display.
<div style="border: 1px solid black; padding: 5px; width: 40px; margin: 0 auto;">9</div>	<div style="border: 1px solid black; padding: 5px; width: 150px; height: 40px; margin: 0 auto; display: flex; align-items: center; justify-content: center;"> 00 * 39 </div>	Using the 'CI' you can correct your entry if needed. After you press 'Enter' the hand held controller will check the status of the feedback encoder and show the results.
<div style="border: 1px solid black; padding: 5px; width: 60px; margin: 0 auto;">Enter</div>	<div style="border: 1px solid black; padding: 5px; width: 150px; height: 40px; margin: 0 auto; display: flex; align-items: center; justify-content: center;"> 00 * 39 </div> <div style="margin-top: 5px; font-family: monospace; font-size: 0.8em;"> b 1 3 4 6 8 </div>	In the upper row of the display you will see "OD" to indicate that you are displaying feedback information, and next to it the address of the feedback encoder read. In the lower row, next to the 'b' the status of the 8 inputs on the feedback encoder address will be shown. In the example, a display of 1 3 4 6 8 means that the feedback inputs 1, 3, 4, 6 and 8 are active and inputs 2, 5, and 7 are inactive.

If you enter a smaller or larger value, then you will again be prompted to enter a turnout address.

If you want to show the status of another feedback encoder, then use 'Cl' to clear the displayed address and enter the new one.

If you enter a feedback encoder address, but there is no feedback encoder with that address connected to the feedback bus, then a "-" will be displayed behind the address. There will also not be any display in the binary form.

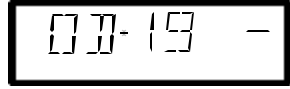

The valid range for entry of feedback encoder addresses is 1 to 128. If you enter a smaller or larger value, then you will again be prompted to enter a feedback encoder address.

14 Reading/Changing decoder settings

In this large section you will find out:

- what "programming" really is in *Digital plus by Lenz*®
- what settings can be changed by programming
- what different methods can be used for programming
- how you proceed when programming

14.1 What is programming and what purpose does it serve?

Each decoder has a number of settings that can be changed to customize that decoder to its particular use. This can be a locomotive decoder, an accessory decoder or a feedback encoder.

Each of these settings is stored in a memory location inside the decoder. These memory locations are similar to index cards in a box. Each decoder has such an "index box". Each "card" has one setting of the locomotive decoder written on it, for instance on "card" number 1 the locomotive address, on "card" number 3 the acceleration delay. In other words, one card for each decoder setting. Depending on the number of settings available in this decoder the "index box" is sometimes bigger, sometimes smaller. On each "card" is a numeric value, the general value range of such a card is 0 to 255.

Since you can change the values on these index cards again and again, they are also referred to as variables. Using these variables, settings are determined, **configured**, and hence in the US we developed the term '**Configuration Variable**' (**CV**). From now on we will not refer to index cards any longer, but use the correct term CV. Using CVs the settings or the behavior of a decoder are described.

Which CV contains which information is standardized. For instance CV1 is always the address of a locomotive, CV3 is always the acceleration and CV4 is always the deceleration delay. A description of the available CVs and their settings is described in the *Digital plus by Lenz*® locomotive decoder manuals. This information can be downloaded in the internet from www.lenz.com, obtained from your model railroad retailer, or by sending a stamped, self-addressed envelope to Lenz Elektronik.

Not all the possible values from the range 0 to 255 are always valid. For the setting “basic address”, CV1 only the value from 1 to 99 is valid. For CV53 (dimming the function outputs) on the other hand, the full range of 0 to 255 is valid.

There are also “index cards” that contain the entered number in another way of writing to make the use easier. This other way of writing is called **binary writing**. Here the numeric value is not written using the digits 0,1,2,3,4,5,6,7,8,9, but using only the numbers 0 and 1.

It is easier to imagine those CVs as a series of 8 switches, that can be on or off. These switches are referred to as “Bits”. If the switch is on, then we say “the Bit is set” or “the Bit is 1”. If the switch is off, then we say “the Bit is erased” or “the Bit is 0”.

Example: CV29 binary switch settings

In this CV several settings are stored. If a certain setting is on or off depends on one of the 8 switches (bits):

Switch	turned on (=bit set "1")	turned off(=bit erased "0")
1	Locomotive runs backwards when the direction arrow points 'up'	Locomotive runs forwards when the direction arrow points 'up'
2	Locomotive operates in 128 or 28 step mode	Locomotive operates in 14 or 27 step mode
3	Locomotive can also run in analog operation	Locomotive can't run in analog operation
4	not used	not used
5	Decoder uses user-programmed speed curve	Decoder uses factory default speed curve
6	Locomotive is controlled with extended address from CV17 and CV18	Locomotive is controlled with basic address from CV1
7	not used	not used
8	not used	not used

14.1.1 Difference between Operation mode programming and service mode programming

When you use operations mode programming or “**Programming on the Main**”, the locomotive can be operating anywhere on your layout. To communicate with this exact locomotive and differentiate it from all others, you must know the address of this locomotive. In operations mode programming the locomotive receives a command that can be written something like this:

“Locomotive number 1234, enter the value 15 in CV4.”

Only the locomotive with address 1234 will carry out this command.

When you use service mode or “**programming on the programming track**” it is not necessary to know the address of the receiver. In this case the decoder will receive a command in this format:

“Write the value 15 in CV4”

Each and every decoder that receives this command will also carry it out.

14.1.2 When do you need the programming on the programming track?

1. Whenever you want to change the address of a locomotive decoder.
2. When you want to display information currently stored within the CV
3. There are also ***Digital plus by Lenz*** ® decoders that do not understand the “Programming on the Main” mode.

Many entry level, older locomotive or most accessory decoders do not have the capability to be programmed using operations mode programming. For all these decoders you need to use the “Programming on the programming track” mode.

14.2 Programming on the Main - PoM

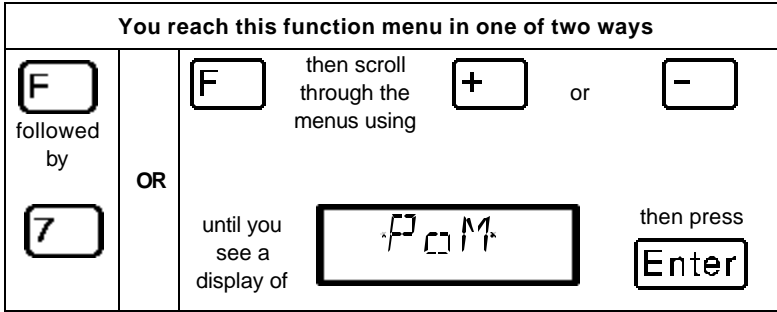

Programming on the main is mainly of interest for locomotive decoders, since using PoM the settings of the decoder can be changed on the normal “operating” track. That means the locomotive can be anywhere on your layout. To change a setting using POM the decoder does not have to be placed on the programming track.



The use of PoM requires command station version 3 or higher or a SET02/03. The menu PoM is not available when connecting LH100 to a command station with a software version prior to 3.

To change the settings in a particular locomotive using PoM, you must know the address of this locomotive, all programming commands are dependent on the locomotive address. The command station will send a command in this manner: “Locomotive number 132 store an acceleration delay of 10!” This command will be carried out only by the locomotive with address 132 and none other. If the address isn’t known or you want to change the address of a locomotive, you need to use the mode “Programming on the Programming Track” starting on page 54.

14.2.1 Which settings can be changed with PoM?

All the CVs present in a locomotive decoder can be changed with PoM, with the exception of the basic address in CV1 and the extended address in CV17 and CV18. For this reason you should be careful as you proceed, since if you make a mistake in programming, the locomotive may not operate until the CV value is corrected! In day-to-day operation you will probably change the CVs for the acceleration and deceleration the most frequently.

14.2.2 Which locomotive decoders can have their settings changed with PoM?











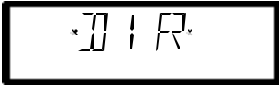

All Digital plus locomotive decoders from the XF and XS series on can use PoM. If you use locomotive decoders from other manufacturers, please refer to their manuals for compatibility with PoM.

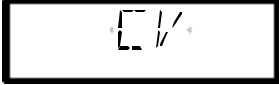
Locomotive decoders that do not use PoM, are programmed on a special programming track. For more information on this, see the section "Programming on the Programming Track" starting on page 54.

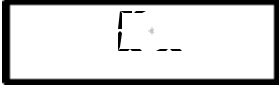
14.2.3 Programming a numeric value into a CV — step by step approach:

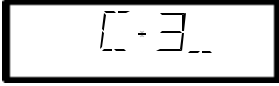
In the following example we will change the acceleration delay on a locomotive with address 3 using PoM:

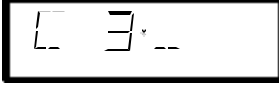
☞ Before you switch to PoM, you must call up the address of the locomotive whose settings you want to change!

Press	On the display you see	Explanation
		Call up the locomotive whose settings you want to change using PoM
	Display shows the most recently selected menu	
		
		Page with the '-' key until the "CV" display is shown.
		Now enter the number of the CV whose value you want to change.
		The value for the acceleration delay is stored in CV3
		Enter the value that you want to write into the CV
		If you make a mistake, you can use 'C' to erase the last digit.

Enter

With 'Enter' you start the programming sequence and change the value of this CV in this locomotive.

Esc

With 'Esc' you return to entry of a CV number. You can now directly go to changing another CV

Esc

If you want to get back to controlling a locomotive, you press 'Esc' 2 more times

Esc

The procedure is always the same, regardless of which CV you want to change with PoM. You simply enter the corresponding number of the CV and then the value you want stored in that CV.

14.2.4 Shortcut to the most common settings

We have built in a convenient mode for settings the most commonly changed CVs using PoM. In this mode you don't have to know or look up the number of the CVs,

Press	On the display you see	Explanation
		Call up the locomotive whose settings you want to change using PoM
F	Display shows the most recently selected menu	
7		
-		Page with the '-' key until you get to the display "DIR"
Enter		Now you can page through the most important settings. "STV" stands for starting voltage (CV2)
+		"ACC" stands for acceleration delay (CV3)

+	DCC	"DCC" stands for deceleration delay (CV4)
+	MAX	"MAX" stands for maximum speed (CV5). Please note that not all decoders use CV5.
+	STV	Page until you see the setting you want displayed.
Enter	STV _	Use 'Enter' to select the desired setting.
6	STV 6 _	Now enter the value you want.
Enter	STV	'Enter' starts the programming, and once it is done, you are returned to selecting the setting.

14.2.5 Setting and erasing bits (switches) using PoM — step by step procedure

Many CVs don't use numeric values, but individual bits (switches) for particular settings. It is then much easier to get the needed setting by setting and erasing the individual bits (switches), instead of calculating the corresponding numeric value and then program it into the CV (which of course also works).

Press	On the display you see	Explanation
		Call up the locomotive whose settings you want to change using PoM
F	Display shows the most recently selected menu	
7	DIR	
-	CV	Page with the '-' key until the display shows "CV"
Enter	_	Enter the number of the CV you want to change. In this example we will select CV29

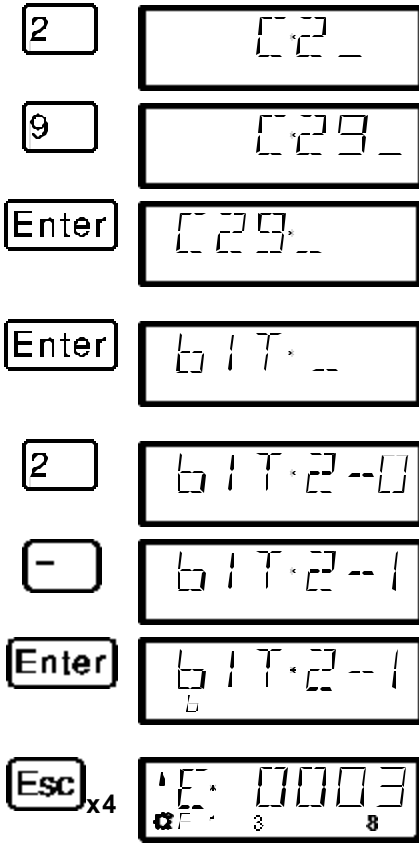

First press the '2' key

Next press the '9' key. When you press enter this will select CV29.

Instead of entering the decimal number that you want to program, press Enter again to enter bit mode.

In bit mode you can enter a value from 1 to 8 for the bit you wish to change. In this example we will select bit 2.

You can toggle between a value of 0 and a value of 1 using the '-' or '+' keys

When you are ready to program press the 'Enter' key.

A "P" will be displayed briefly on the bottom of the display to indicate that the programming has taken place.

Press the 'ESC' key four times to completely exit PoM and return to operating trains.

With PoM you can only write values into a CV, not read them out. You determine the success of your programming by observing the actual change of the setting in action.

14.3 Programming on the Programming track

You reach this function menu in one of two ways

<div style="border: 1px solid black; padding: 2px; margin-bottom: 5px; text-align: center;">F</div> followed by	OR	<div style="border: 1px solid black; padding: 2px; margin-bottom: 5px; text-align: center;">F</div> then scroll through the menus using	+	or	-
<div style="border: 1px solid black; padding: 2px; margin-bottom: 5px; text-align: center;">8</div> until you see a display of		<div style="border: 1px solid black; padding: 5px; display: inline-block;"> PROG </div>			then press <div style="border: 1px solid black; padding: 2px; margin-bottom: 5px; text-align: center;">Enter</div>

In section 13.12 the reasons for using service mode programming were explained. In this section you will learn about the various methods for using service mode programming using a special programming track. For programming the locomotive address and the other key settings we have created a very convenient method.

14.3.1 What is a programming track?

Using "Programming on the programming track" it is not necessary to know the address of the decoder. In this approach, the decoder will receive for example this command:

"Enter the value 15 in CV4!"

To be sure that only one particular decoder receives the programming command, you must make sure that when you are programming on the programming track only this one decoder is will receive this command. This is most easily done by using a track that is

1. electrically isolated from the rest of the layout, and
2. on which you place only the desired locomotive you wish to program.

14.3.2 Where is the programming track / the decoder connected?

The command station LZ100 has special connection terminals for the programming track. These connections are labeled P and Q. More information about them is found in the operation manual for command station LZ100.

If you want to program an accessory decoder, then you don't need a track. Simply connect the decoder directly to terminals P and Q on the LZ100.











14.3.3 Programming and reading a locomotive address and other key settings: The "DIR" menu

The simplest way to program a locomotive address is with the "DIR" menu (for "Direct"). Using this menu has the advantage that you don't have to know or look up the number of the CV, instead easy to understand abbreviations help you.

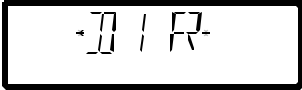

The procedure for reading and writing is identical, and the following simple principle applies: In all places where the value to be programmed needs to be keyed in, you can read out the current value in the decoder, when you immediately (that is without entering a numeric value) press the 'Enter' key.

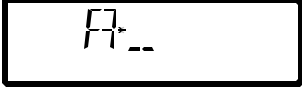

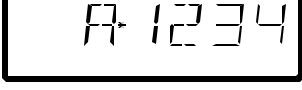

Step by step procedure to read a locomotive address:

Press	On the display you see	Explanation
	The most recently selected menu is shown	
	 (flashes)	Programming on the programming track
	The most recently selected programming mode is shown	
		Page with 'L' until "DIR" is displayed.
		If "ADR" is not displayed, then use 'L' to page until you get to this display.
		Start reading out the address at this display using 'Enter'.
		Now the locomotive address stored in the locomotive decoder is read and shown. During the reading process, the second row in the display shows a "L".

You can return to controlling locomotives by 'Esc' 3 times, or you can press 'Cl' to go on to write a new locomotive address.

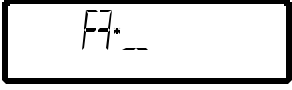
Step by step procedure to writing a locomotive address:

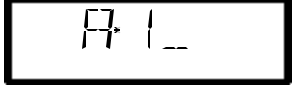
Proceed as described above for "reading an address". If you want to you can read out the currently stored address. After reading the address you then press 'Cl'.

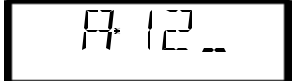
		At this point you can begin with entering the new address (or use 'Enter' to read out the address).
		Now key in the desired address.
		If you make a mistake, you can use 'Cl' to clear the last entry.

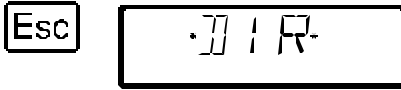
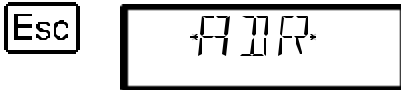
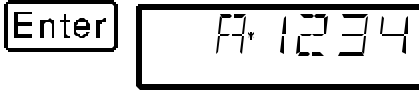
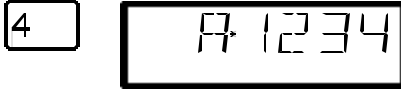
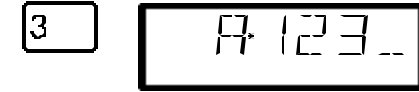

Now the address keyed in is written in the locomotive decoder. During the programming sequence the second row of the display shows a "P".

When you want to leave the programming of an address, then use 'Esc' to return to selecting the setting.

Another 'Esc' brings you back to selecting the programming mode.

The final 'Esc' takes you out of programming and returns you to controlling a locomotive. The address of the last selected locomotive (or MU) is shown.

☞ The 2-digit addresses (1-99) are stored in the locomotive decoder in CV1, 4-digit locomotive addresses (100-9999) in CV17 and CV18. When programming with "DIR" you don't have to think about this. All necessary settings are automatically made in the locomotive decoder for you!

☞ If when reading the address you get this display

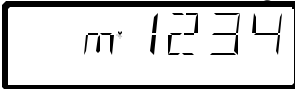



then the locomotive decoder is assembled into a multi-unit consist address. Press the '+' key' and the MU address that is stored in CV19 is read out and shown:



☞ If you then key in and program a new address, the new address is stored in the decoder and the MU address in CV19 is erased!

14.3.3.1 Additional settings that can be programmed and read out with the “DIR” menu

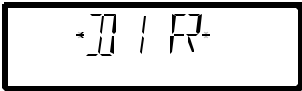
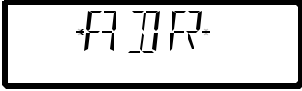

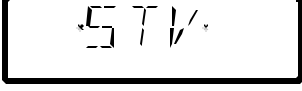
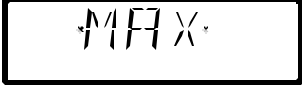











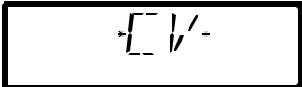

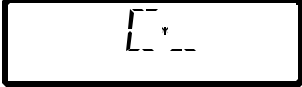
Aside from the address, the “DIR” menu offers you a simple method for programming the other key locomotive settings.

Press	On the display you see	Explanation
F	The most recently selected menu is shown	
8	 (flashes)	
Enter	The most recently selected programming mode is shown	
-		Page with '-' until "DIR" is displayed
Enter		First you are prompted to read/write the locomotive address.
+		The '+' or '-' key lets you page through the other settings. "ACC" stands for acceleration delay (CV3).
+		"DCC" stands for deceleration delay (CV4).
+		"STV" stands for starting voltage (CV2).
+		"MAX" stands for maximum speed (CV5). Please note that not all decoders use CV5.

If you want to show the value of one of the settings (CVs), press 'Enter', when the setting is displayed,. To change the value key in the desired value followed by 'Enter'. To read out the value in the CV pressing 'Enter' without entering any new value. (the same as reading and writing a locomotive address described previously).

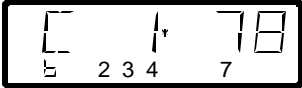
14.3.4 Reading and writing by entering the CV — step by step directions

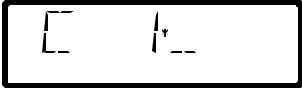
Many additional decoder CVs can be written and read, in addition to the settings that can be programmed with the “DIR” menu,. While we will only show CV1 here as an example, the procedure is the same for all CVs,

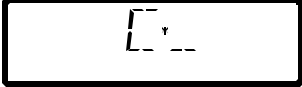
Press	On the display you see	Explanation
	The most recently selected menu is shown	
	 (flashes)	Select “Programming on the programming track”
	The most recently chosen programming mode is shown.	
		Use the ‘←’ key to page to the display of “CV”.
		Here enter the number of the CV that you want to read / write. Values between 1 and 256 are allowed
		In this example CV1 is chosen. If you make a mistake, you can erase the last digit with ‘C’.
		In this place you can either enter the value that you want to program, or read out the value of the CV by pressing ‘Enter’ again.
		The value in the CV is read out and shown. In this case the value 78 was found in CV1.
		Press ‘C’ to erase the value from the display. Now you can enter a new value or
or 		If instead of pressing ‘C’ you press ‘Esc’, you return to the display that allows you to select another CV to read or write.

Esc

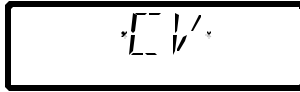

Another 'Esc' brings you back to the menu that allows you to select the programming mode.

Esc



With a final 'Esc' you leave the programming and return to controlling locomotives.

☞ Make sure you do not exceed the valid range of values for the decoder when entering data! If needed, refer to the operation manual of the decoder. You can clear an entry made in error with the 'C' key.

☞ If your decoders do not support the "CV" programming mode, you can program these decoders in what is referred to as "register mode" or in "paged mode". For more information, see section 13.3.5 and 13.3.6 starting on page (⇒p.).

☞ CV7 (version number) and CV8 (manufacturer information) can only be read, not written.

14.3.4.1 Setting and erasing bits in a CV

In programming on the programming track you can also set or erase individual bits (switches) in CVs. Proceed as follows:

Press	On the display you see	Explanation
	The most recently selected menu is shown	
	(flashes)	
	The most recently selected programming mode is shown	
		Page with '-' or with '+' until "CV" is displayed
		Enter the number of the CV you want to read/write here.

2	02_	In this example CV29 is used. If you make a mistake when entering, you can erase the last digit with 'Cl'.
9	029_	
Enter	029.	Read out the value of the CV first. This is done by pressing 'Enter'.
Enter	029. b 2 3 6	The value in the CV is read and shown. In the lower row the displayed digits show you which bits are set in this CV. In this example bits 2 and 3 are set.

 Rule: Bits shown in the second row are set (have a value of 1), bits that are not shown are clear (have a value of 0).

If you want to make changes, then press the corresponding numeric keys. In the following example bit 1 is to be set and bit 3 erased:

1	029. b 1 2 3 7	Pressing the '1' key shows that bit 1 is to be set. The resulting decimal value is automatically shown in the upper right.
3	029. b 1 2 3	By pressing the '3' key, the display of bit 3 is erased.
Enter	029. P 1 2 3	Using 'Enter' the CV is re-written. During programming the "b" in the second row changes to a "P".
Esc x3 times	E. 0003 P 1 3 8	Press the 'Esc' key 3 times to completely exit service mode

















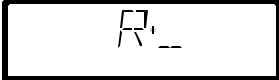

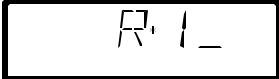

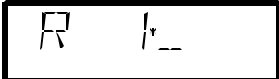
14.3.5 Reading and writing by entering using register mode

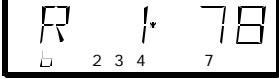
Older **Digital plus by Lenz®** decoders (series produced before 1996) and decoders from some other manufacturers do not support programming by entering the CV.

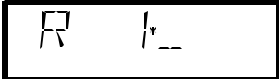
These decoders are programmed by what is called "register" mode. Some accessory decoders must also be programmed in this manner.

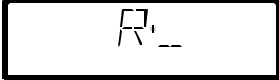

For more details, see the operation manual for the decoder.

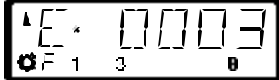
The procedure for reading / programming in register mode is the same as when programming using CV mode, with the exception that there are only 8 registers to choose from.

Press	On the display you see	Explanation
	The most recently selected menu is shown	
	(flashes)	Select "Programming on the programming track"
	The most recently selected programming mode is shown	
		Use '-' or '+' to page until "REG" is shown on the display.
		Here enter the number of the register that you want to read/write. Values of 1 to 8 are allowed.
		In this example register 1 is selected. If you make a mistake, you can erase the last digit with 'Cl'.
		In this location you can either enter the value that you want to program, or read out the value in the register by pressing 'Enter' again.
		The value in the register is read and shown. In this example the locomotives address is 78.
		Press 'Cl' if you want to enter a new value or press 'Esc'.
or		
		After you have read or written a register, use 'Esc' to return to selecting another register.
		Another 'Esc' takes you back to selection of programming mode.
		With the last 'Esc' you leave the programming and return to controlling locomotives.

14.3.6 Reading and programming by using paged mode



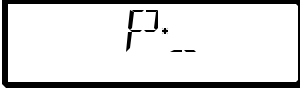



Paged mode is an older and slower method for reading and setting CVs. This mode of programming can be used to program many decoders that do not support the faster Direct CV Mode. The procedure for programming in Paged mode is identical to the procedure in Direct CV mode. The following assumes you have already entered programming and are at the programming menu.

Press	On the display you see	Explanation
		Use '-' or '+' to page until the display shows "PAGE"
		Use 'Enter' to select the "PAGE" programming mode

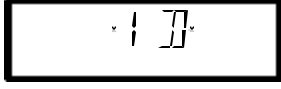
 You can program any CV in the range between 1 and 256 using "Paged Mode"

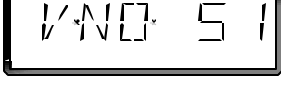

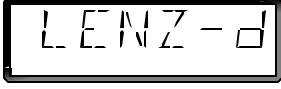

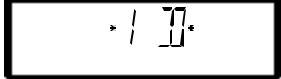
14.3.7 Using ID Programming Menu

Often you need to know version of the decoder and the manufacturer of the decoder. ID mode is a simple method that reads both of these values for you.

Press	On the display you see	Explanation
		Use '-' or '+' to page until the display shows "ID".
		Use 'Enter' to check the identity of the decoder. The first number that is displayed is the decoder's version number.
		Use the '-' or '+' key to check the manufacturer of the decoder.
		Press the 'Esc' key to return to the programming menu.

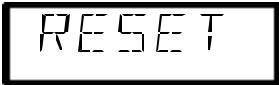
14.3.8 Using the Reset Programming Menu

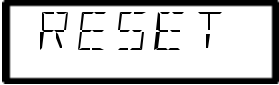
Sometimes it is desired to reset the decoder to factory default. Not all decoders support a reset command. In this case it is necessary to rewrite all the CVs back to a known condition. The LH100 "RESET" programming writes all the important CVs used by **Digital plus by Lenz**[®] decoders back to a factory default condition.

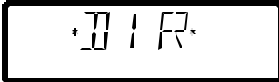
Press	On the display you see	Explanation
		Use '-' or '+' to page until the display shows "RESET".
	 flashes	Press 'Enter' the display will now blink "RESET" you can abort the operation now by pressing the 'Esc' key, or continue with the reset procedure by pressing the 'Enter' key a second time
	Various CVs are displayed 	You will see a series of CV values flash in the display. When the procedure is completed the display will return you to the initial programming menu.

The reset command uses direct CV mode to set the following CVs: CV1 to 3; CV2 to 7; CV3 to 0; CV4 to 4; CV5 to 15; CV9 to 1; CV19 to 0; CV29 to 2; CV30 to ; CV50 to 1; CV51 to 0; CV52 to 64; CV53 to 0; CV54 to 1; CV55 to 2; CV56 to 30; and CV60 to 3.

14.4 Error messages during programming

If you made an error during programming, a message will be shown in the display:

ERR 01	When programming or reading a decoder, a power overload (short circuit) was detected. The decoder may not be correctly connected or may be defective.
ERR 02	When programming or reading a decoder, no decoder acknowledgement was detected. That could mean that the decoder is not correctly connected to the programming output on command station LZ100 (for example the digital locomotive may not be properly placed on the programming track) or the decoder is not functioning properly.

Press the 'CI' key to clear the error message from the display and return to locomotive control.

14.4.1 Display on other connected hand held controllers

When the LZ100 enters programming mode, power to the layout is stopped. While the command station remains in the programming mode, all displays other than the one performing programming operations will show "PM".

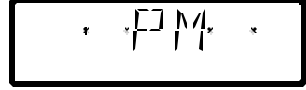

15 Configuring the LH100 handheld using the SYS menu

In this section you learn about:





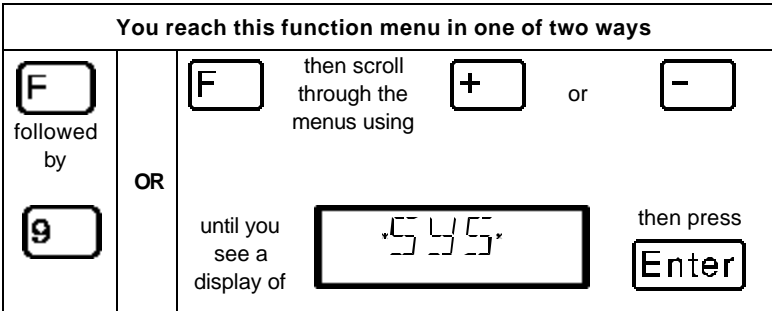





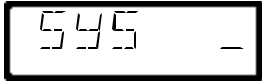

- how to configure the LH100 handheld
- how to determine the software version and system version

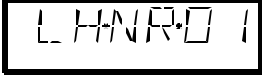
Using the SYS menu it is possible to customize the operation of an LH100 handheld and also to learn about characteristics of the system..

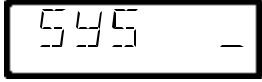

15.1 SYS_0: entering the XpressNet device address

All the input devices connected to XpressNet must have their own *device address* for the correct information exchange with the command station. You must therefore make sure that all the connected devices have different device addresses. You can currently connect up to 31 devices to XpressNet, which means that each device must have a unique address between 1 and 31. Every LH100 is programmed to device address 01 by factory default. If you are going to use two or more hand held controllers, then you must program different addresses for each hand held controller.

Press	On the display you see	Explanation
	The most recently selected menu is shown	
		This is the prompt to enter the setup that you want to read/change.
		SET0 is setting the XpressNet address. The currently set address is shown.
		With 'C' you clear the display to allow entering another address.
		In this example address 2 is entered. If you make an error, you can use 'C' to erase the last entry.
		Using 'Enter' the newly keyed in address is stored and you go back to the menu.
		'Esc' returns you to controlling locomotives.

 Please make note when you set the XpressNet address to which device your LH100 is connected:





Command station LZ100 addresses XpressNet devices 1 to 31.

The SET02, SET03 and the compact address the devices 1, 2, 3, 29, and 31.

You must not use an address that already has a device set to it.

15.2 SYS_1: the system menu

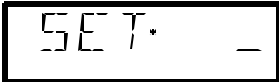

The system menu is where primary settings that affect the operation of LH100 hand held controller itself are made.

Press	On the display you see	Explanation
	The most recently selected menu is shown	
		This is the prompt to enter the setup of the parameter you want to read/change.
		At the "Set" display you enter one of the following numbers depending on the operation you want to perform.





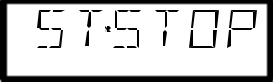

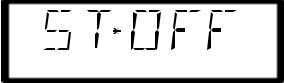

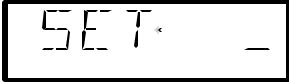

Following are the settings that you can change within the "SYS_1" menu.

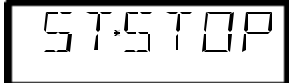
15.2.1 SET 1: Setting the function of the 'Stop' key

You can use this system setting to configure the operation of the 'St' Stop key.

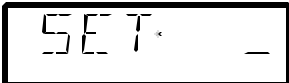
		
the locomotives are stopped, but the power to the track remains on	or	the power to the track is turned off



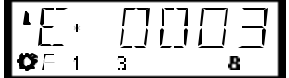





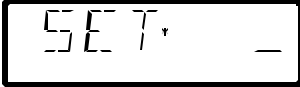

To configure this setting go to the SET menu:

Press	On the display you see	Explanation
		You reach this display by pressing 'F' followed by '9' followed by '1'.
		By pressing the '1' key, the current setting is shown. (stop is the factory default.)
		With the '+' (or '-') key you can change the setting of the mode of 'St' key.
		'Enter' confirms the change, 'Esc' lets you leave the menu without changing the setting.
		You leave the system menu with 'Esc', which takes you back to selecting the settings.
		With another 'Esc' you return to controlling locomotives.

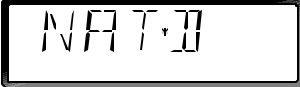
15.2.2 SET 2: language selection

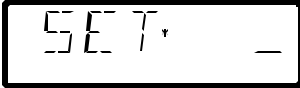
Currently, the LH100 allows you the choice between German and English (US) display text.





To configure this setting go to the SET menu:

Press	On the display you see	Explanation
		You reach this display by pressing 'F' followed by '9' followed by '1'.
		The currently selected setting is shown: The example shows English as the current setting
		With '+' or '-' you can change the language in the display text.
		'Enter' confirms the change, 'Esc' lets you leave the menu without changing the setting.
		You leave the system menu with 'Esc', which takes you back to selecting the settings.
		With another 'Esc' you return to controlling locomotives.

15.2.3 SET 3: contrast setting

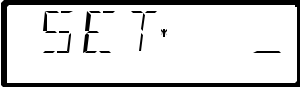
For better readability, the LH100 has a contrast setting for the display.

To configure this setting go to the SET menu:

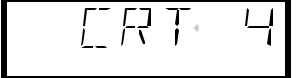
Press	On the display you see	Explanation
		You reach this display by pressing 'F' followed by '9' followed by '1'.
		By pressing the '3' key, the currently selected contrast setting is shown
		Using the '+' key you can increase the value.

-	▼ CRT 3	With the '-' key you lower it. While you are pressing the key, the corresponding arrow is shown in the display.
-	CRT 2	Each keystroke immediately changes the contrast of the display, so that you instantly can evaluate the result of the change.
Enter	SET. _	'Enter' confirms the change, 'Esc' lets you leave the menu without changing the setting.
Esc	SYS _	You leave the system menu with 'Esc', which takes you back to selecting the settings.
Esc	▲ E 0003 ⚙ F 1 3 E	With another 'Esc' you return to controlling locomotives.

15.2.4 SET 4: mode of counting bits in the display

The section "Setting and erasing bits" described how you can change individual bits in CVs. When doing so, the bits are counted starting with 1.

Some decoders from other manufacturers may start counting the bits with 0. To make it easier be able to get a display corresponding to this mode of counting, you can set the mode of counting for the bit display in SYS_4.

To configure this setting go to the SET menu:

Press	On the display you see	Explanation
	SET. _	You reach this display by pressing 'F' followed by '9' followed by '1'.
4	BIT 1-8	The currently selected mode is shown. (Mode of counting 1-8 is factory default.)
+	BIT 0-7	With the '+' (or '-') key you can change the setting of the mode of counting.
Enter	SET. _	'Enter' confirms the change, 'Esc' lets you leave the menu without changing the setting.

Esc

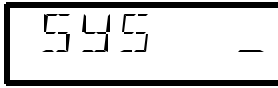

You leave the system menu with 'Esc', which takes you back to selecting the settings.

Esc

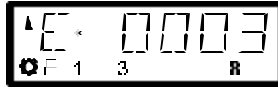

With another 'Esc' you return to controlling locomotives.

15.2.5 SET 5: Erasing locomotive addresses from the command station stack

As described previously, the LZ100 command station sends operation data repeatedly to all locomotive addresses contained in its stack.











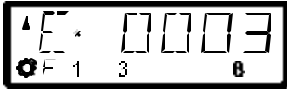

If you fill the LZ100 locomotive stack you can erase locomotive addresses that are not needed for operation from the stack. This setting is user controllable.

- ☞ You can only set this setting when using a command station version 3 or higher.
- ☞ To be able to erase locomotive addresses from the command station stack, this system setting must be set to "CL ON".

To configure this setting go to the SET menu:

Press	On the display you see	Explanation
		You reach this display by pressing 'F' followed by '9' followed by '1'.
		The current setting is shown. (Off is the factory default.)
		With the '+' (or '-') key you can change the setting.
		'Enter' confirms the change, 'Esc' lets you leave the menu without changing the setting.
		You leave the system menu with 'Esc', which takes you back to selecting the settings.
		With another 'Esc' you return to controlling locomotives.

With CL set to ON you can proceed to erase a locomotive address from the command station stack using the following procedure.

Press	On the display you see	Explanation
		You are in controlling locomotive
		First erase the display by pressing the 'CI' key
		Use '-' or '+' to page through the locomotive stack until you find the address you want to erase.
	 (flashes)	With the 'CI' key you start the erasing procedure. 'Enter' completes the erasure while 'Esc' aborts the operation.
		With 'Enter' the address is now erased from the stack. The next address in the stack is shown for selection.
		You can now continue to page through the stack until you find a locomotive you wish to operate.
		With 'Enter' you can select an address to control, direction of travel and status of the functions will now be shown.



Use the erasing a locomotive address from the command station stack with care. If an address is erased, the command station will not send this data to the locomotive any longer. If power is interrupted, the locomotive could therefore lose the information. All command station data about the configuration of this locomotive will also be lost.

15.2.6 SET 6: LH100 Reset to factory defaults

The "SYS-6" command can be used to reset the LH100 to factory default.

To configure this setting go to the SET menu:









Press	On the display you see	Explanation
	SET. _	
6	RESET	The LH100 display alternates between "RESET" and "LH100"
	alternates with	
	LH-100	
Enter	RESET	'Enter' confirms the desire to perform a reset. Press 'Enter' a second time to start a reset or 'Esc' to abort the operation.
	blinks quickly	
Enter	RESET	The reset operation starts with "Reset" on the LH100 display. After about 5 seconds the display goes through several displays as it resets
	blinks slowly	
	L. 0003	When the reset is completed the LH100 returns to locomotive operation.

☞ A Reset operation causes the following settings to change

- XpressNet address = 1
- Function 'St'-key = STOP
- language = German
- contrast LCD = 2
- bit edit = 1...8

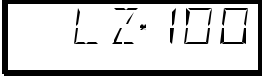
15.3 SYS_7: Displaying the command station ID

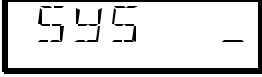

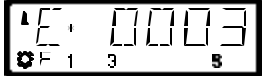





Using this function you can display the identification of the command station in use.

Press	On the display you see	Explanation
	The most recently selected menu is shown	
		This is the prompt to enter the setup that you want to read/change.
		The currently used command station is shown.
		You leave the system menu with 'Esc', which takes you back to selecting the settings.
		With another 'Esc' you return to controlling locomotives.

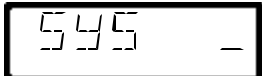
 This function is only available when using a command station LZ100 version 3 or higher.

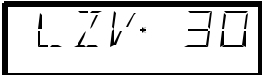

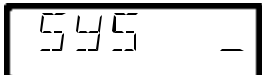

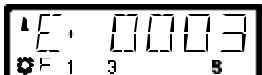



15.4 SYS_8: Displaying the version number of the command station

Using this function you can display the version number of the command station in use.

Press	On the display you see	Explanation
	The most recently selected menu is shown	
		This is the prompt to enter the setup that you want to read/change.
		The software version number of the command station in use is shown.
		You leave the system menu with 'Esc', which takes you back to selecting the settings.
		With another 'Esc' you return to controlling locomotives.

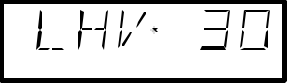
15.5 SYS_9: Displaying the version number of LH100

Using this function you can display the version number of LH100

Press	On the display you see	Explanation
	The most recently selected menu is shown	
		This is the prompt to enter the setup that you want to read/change.
		The software version number of LH100 is shown.
		You leave the system menu with 'Esc', which takes you back to selecting the settings.
		With another 'Esc' you return to controlling locomotives.

16 Expanding SET-01

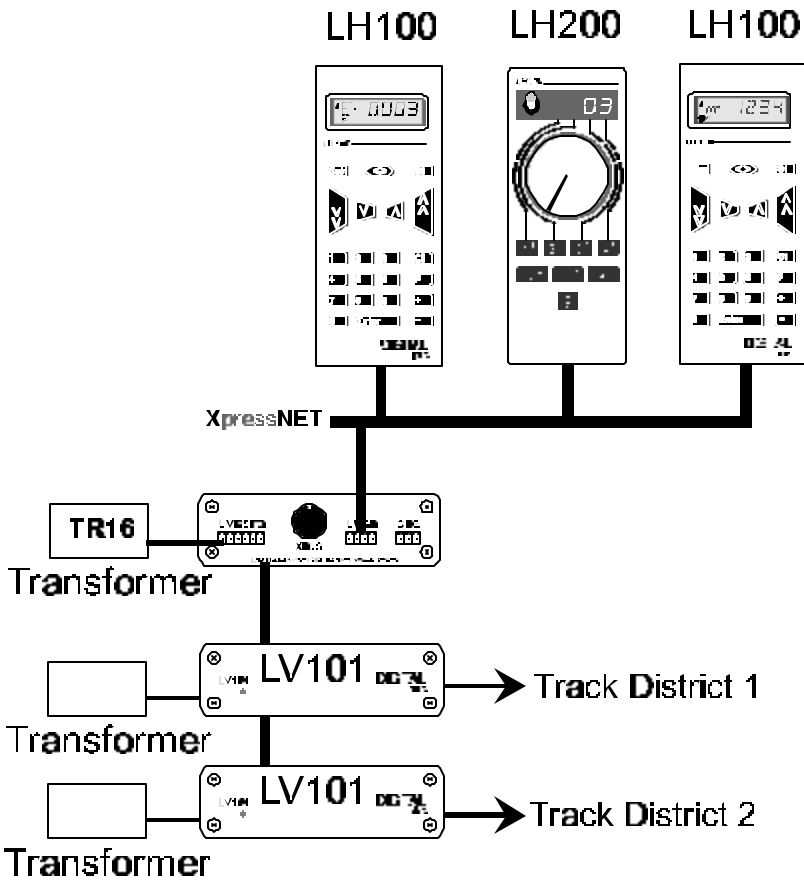

In this section you will learn:

- how to connect more input devices (handheld controls etc.) to your SET-01
- how you satisfy a larger power requirement for your model railway

16.1 Adding XpressNet to allow additional input devices

Your **Digital plus by Lenz**® SET-01 has the ability to easily expand using its support of XpressNet. XpressNet is a leading model railroad high speed network protocol. It is based on the electronic industry standard RS-485 hardware. The key advantages of this protocol are its expandability and the fact that it is supported by a growing number of Model Railroad manufacturers. For wiring SET-01 to support XpressNet refer to "Wiring XpressNet" starting on page 91.

XpressNet input devices cover a wide variety of options including a variety of handhelds, Tower Cab, computer interface and transition modules, that is, all devices from which you control your model railway. In SET-01 the LZ100 is the Command Station, it not only generates the track format, but also evaluates information from other XpressNet-input devices and converts them into control commands for locomotive decoders and turnout decoders. The XpressNet network itself is the link between additional input devices and the command station LZ100.

Each device on the XpressNet has to have its own number, referred to as an XpressNet address. This allows the command station to distinguish these devices from each other and address them. Up to 31 XpressNet devices can be connected to SET-01.

To assign an XpressNet address to a specific device please refer to the operating manuals for these devices.

The LH100 and LH200 handhelds operating as additional devices on the XpressNet of SET-01, are what is referred to as a walk around device. This means that they may be unplugged and plugged in again as often as desired during operation. If you do this you can achieve a high level of mobility through these devices. You can attach as many XpressNet connectors to your model railway layout as desired, so that you can always plug in your input device where you need it at the time. You will find information on this in the section "Wiring XpressNet" which starts on page 91.

16.2 More power through more power stations

As is the case with conventional systems, a sufficient power supply is required for reliable functioning of your **Digital plus by Lenz®** system. Locomotives, coach lighting, points, signals, etc. receive their power and their control information from the power station. If the total electricity consumption of everything connected to the LV101, exceeds 52 Volt Amps the LV101 protective system is activated.

The power consumption of your model railroad arises from:

- locomotives in operation – 200 mA to 2000 mA depending on the size and the freight attached. You should plan on 500mA per locomotive for size N, on 8000mA for size H0, and on 2000mA for larger gauges. If you use these guidelines you will usually still have reserves left.
- locomotives which are not in operation – without lighting draw only 2.5 mA, with lighting approx. 50mA per bulb
- coaches with lighting –approx. 50 mA per bulb

With a LV101, the power consumption of all locomotives in operation at the same time (plus the power consumption for the lighting in the coaches) must not exceed 52 volt amps. If the power consumption needs of your model railway is greater and if as a result the power from the LV101 that comes with the SET-01 is not alone sufficient for the supply of your system, it will be necessary for you to divide the track system into several supply areas (called power districts). Further LV101s can supply each additional power district with a current of approx. 52 volt amps each.

The number of power stations you need depends on the total power requirement of your model railroad. To calculate the total power requirement simply add up the total used by each of the individual power consumers. You can use the approximate values given above. Divide the total power requirement by 3 and round the result up to the next whole number. Now you have the number of LV101 power stations which are needed.

The additional LV101s receive their control signals from the terminals C and D of the first LV101. Each LV101 should be connected to its own transformer. It is absolutely necessary that the electrical circuits of all LV101s connected to each other have the same polarity. This means that terminal J of the first LV101 and terminal J of the following LV101s must be connected to the same side of the track. Otherwise there will be short-circuits when the sectioning gaps between power stations are crossed.

16.2.1 Connecting additional LV101s

Connect terminals C,D (and optionally E) of the first LV101 with terminals C,D and E of the next LV101. Power each LV101 with its own transformer.

Isolate both rails of the track at the junction of the single supply areas and make sure the polarity is the same.

If you are operating locomotives with offset pickups (common in HO scale brass steam locomotives), Connect terminal C together between all LV101s. This will provide the necessary common connection to operate these locomotives.

You will find further information in the operating manual of the additional LV101.

17 Technical appendix

In this appendix we have collected information for you that may be of interest to the advanced user, or that can help you in case of problems.

In this section you will find:

- Managing the LZ100 locomotive database
- valuable information on the Set-01's, LV101 power station
- information on the wiring of your model railway
- information on wiring the XpressNet network
- further help on terminology and procedures

17.1 Error messages on the display



The LH100 will display an error message on the display if you have done something that was not allowed at this time. To clear the display and either back up or resume operation, just press the



Here is the list of possible error messages

Error	happens during	Explanation
ERR 01	PROG	When programming or reading a decoder, a power overload (short circuit) was detected. The decoder may not be correctly connected or may be defective.
ERR 02	PROG	When programming or reading a decoder, no decoder acknowledgement was detected. That could mean that the decoder is not correctly connected to the programming output on command station LZ100 (for example the digital locomotive may not be properly placed on the programming track) or the decoder is not functioning properly.
ERR 24	DH/MU	The locomotive was not selected or no command to the locomotive was sent prior to setting up the MU/double header.
ERR 25	DH/MU	One of the locomotives of the MU/double header is being operated on another Handheld.

ERR 26	DH/MU	One of the locomotives is already part of another MU/double header.
ERR 27	DH/MU	One of the two locomotives was not at throttle position 0. Locomotives must be stopped before you can combine them into a consist.
ERR 30	Command station stack	It is not possible to erase locomotive from command station stack.
ERR 31	Command station stack	The Command station stack is full. You must remove a locomotive address before you can add another address.
ERR 96	<p>Your LH100 is not able to create a data connection over XpressNet</p> <p>Check if the connection of your LH100 to XpressNet was correctly made. The XpressNet wires A and B may have been switched.</p> <p>The wrong XpressNet address is set. Please note that you have to set an address supported by the command station in use. Unplug the handheld and then plug it back in with the 'St' key pressed and the current addresses will be displayed and can be changed.</p>	
ERR 97	<p>There is an error in the data processing in command station LZ100. All information about speed, direction and extra functions of the locomotives, as well as the status of turnouts and feedback encoders has been erased. The most frequent cause of this is an improper power supply to the LZ100. If this error appears repeatedly, the battery in LZ100 may be dead. This battery ensures that the data is stored even after the power to the command station is turned off. Please contact your model railroad dealer or Lenz Elektronik for replacement.</p>	
ERR 98	<p>The command sent from the hand held controller to the command station is not present in its list of commands. The cause is generally a software version in the command station that does not understand this command.</p> <p>Typical example</p> <p>You are trying to assemble a multi-unit consist, but have connected your hand held controller LH100 to a command station version 2.0 which does not support this feature.</p>	
ERR 99	<p>General system error. The hand held controller did not receive the expected reply to a question or command to the command station. The cause may be interference on the XpressNet. Please check if all wires are connected correctly. If this does not correct the problem it is possible that the command station or the hand held controller is defective. Please contact your model railroad dealer or Lenz Elektronik.</p>	

17.2 The LZ100 locomotive database

The LZ100 maintains a database of all locomotives operated. The database can contain up to 256 entries. Each time you enter a new locomotive address and provide speed or function information the locomotive is added to the database. If you exceed the 256 locomotive limit the LZ100 will initiate an error message. If this occurs you will need to go through the database and remove unneeded locomotives. Removing a locomotive from the database will remove all knowledge of the locomotive from the system. To remove locomotives from the LZ100 database see page (⇒p.71).

17.3 LZ100 Reset

In the rare event that you desire to return the LZ100 to its factory default condition you can perform a LZ100 Reset. To do this call up locomotive 00 on the display of any handheld. Press locomotive function 4 a minimum of 20 times. After about 30 seconds the handheld will appear to lock up as communication from the command station has ended. At this point in time you need to power down your LZ100. The first time you re-power the system you will receive an "ERR 97" on the display. This is normal. Remove power from the LZ100, wait 5 seconds and reapply power. Your system should now be functioning properly.

17.4 Selecting suitable transformers for Set-01

It is important that to select suitable transformers for powering your Set-01. You need two transformers to properly operate your system. One transformer is for the LZ100 and a separate transformer for each LV101. While you can use a single transformer for both the LZ100 and the LV101, bests results are achieved using two separate transformers.

 For the LZ100 we recommend the Lenz UL approved TR16 transformer. This transformer provides 16VA of power at 14 volts.

To power your LV101 you will need a transformer that delivers between 14 and 16V AC for H0 and smaller scales. Voltage that exceed this is wasted in excess heat which reduces the effective capacity of the unit. In order to make it possible for the LV101 power station to deliver the complete 52 volt amps, the transformer also has to be able to deliver a amperage of at least 4A (64 VA). You can use a transformer that delivers less current, but then you will not be able to operate as many trains. The permitted maximum and effective starting voltage of transformers must not exceed 18V AC voltage or DC voltage.

The following transformers are recommended for the LV101:

- Digital plus TR100 (order-no. 26000).(220 volts)
- Digitrax PS515 Power supply (110 volts)
- Atlas Generator (110 volts)
- MRC AH800 Power supply (110 volts)
- Lionel Trainmaster PH1 (note this transformer can power 2 LV101s) (110 volts)

If you wish to use a different transformer, please note that it should be a model railroad transformer with a 'UL','GS' or 'CE' symbol.

17.5 Power Station LV101

In SET-01 the power station LV101 provides DCC power to the tracks. Features include user selectable DCC track voltage, a fault detection LED, and a RJ-45 plug-in connector for connecting the LH200 command station and XpressNet.

The DIGITAL plus Power Station LV101 provides clean and safe DCC power to the track. New circuitry has been developed to reduce noise, which provides exceptionally clean power to operate your DCC equipped trains. Safety features include:

- Short/overload detection that turns off the power to the track whenever a short or overload condition is detected. This protects both your trains and the LV101 electronics.
- Opto-isolation to safely isolate your control bus wiring from your track wiring. This eliminates any possibility for hidden ground loops through your power station.
- Fail Safe runaway protection is provided by requiring a 7 volt signal on the DCC Control Bus (the C and D wires). This prevents the LV101 from accidentally sending out power to the track when the command station stops transmitting packets.

The LV101 provides a fault detection LED located on the front of the unit. When the power station is in use, the LED on the front is lit. In case of an overload of the power station, the LED will flash. In addition, the LED will also flash if no information is being transmitted over the Control Bus (connections **C** and **D**), The LH200 command station is disconnected, the LH200 command station is off or one of the wires is not connected.

The LV101 Power Station was designed to meet all NMRA Standards and RPs including the new the NMRA Control Bus draft RP.

17.5.1 Connecting the LV101 Power Station to the layout

For maximum power, the LV101 should be located near the track being powered, so that the connection between the LV101 and the track is kept as short as possible. Connect the transformer to terminals **U** and **V**. For maximum output power, the transformer voltage should be selected to be close to the DCC track voltage. For HO scale and smaller, a 16V AC or DC transformer is ideal. In order for the Power Station to give off its full 52 VA current, the transformer also needs to be able to deliver a minimum of 4 amps. **The allowed maximum effective output voltage of the transformers must not exceed 18V AC or DC.** See "Selecting a suitable transformer for Set-01" starting on page 82 for more information.

The track is connected to terminals **J** and **K** (see Figures 2 and 3). Use only wire of sufficient gauge to connect to the tracks (minimum 18 gauge) and either use parallel wires or twist the wires to reduce radio interference.

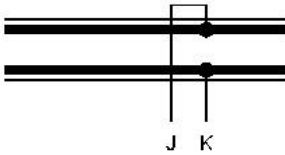

Connecting 2-rail track

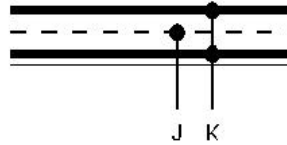

Connecting 3-rail track

The Power Station receives command information from the Command Station via terminals **C** and **D**. These terminals are connected to the corresponding terminals on Command Station LZ100 with a 2-wire cable. To reduce radio interface, these wires should be twisted.

Terminal **E** is only used in conjunction with the LZ100 Command Station. It has no effect for Set-01.

When an overload occurs only the track power district that the LV101 is connected to will shut down. The overload will not affect any other power stations on the layout unless its **E** connection is connected to the LZ100. After a certain time (when the Power Station has cooled down again) the Power Station automatically turns the power supply back on to its Power District. If the overload still is present, it will turn off again after an additional short time.

17.5.2 Six-pin I/O - port

The six-pin phone type jack located on the rear of the LV101 is not used with Set-01.

17.5.3 Installation considerations

There must not be a capacitor connected to the track for interference control. A capacitor is only needed for conventional operations to prevent radio interference. In DCC operation a capacitor corrupts the data format and the error free data transfer is disturbed.

It is normal for the Power Station to get warm during operation. Ensure sufficient airflow around the Power Station to prevent the internal safety circuit from activating during normal operations.

Never allow your layout to operate without supervision! If there is an unnoticed short, the heat build-up could present a fire hazard!

17.5.4 Supplying power to a large model train layout

As in conventionally operated layouts, a sufficient power supply is prerequisite for the safe function of a digital layout.

Locomotives, interior lights in rolling stock, turnouts, signals etc. all get their power from the Power Station, along with their commands. If the devices you have connected to an LV101 together require more than 52 volt Amps, the safety circuit of the LV101 will activate. You will have an overload situation as described in the section "Connecting the Power Station" above.

The current use of your layout is the sum of the following:

- locomotives in operation: depending on scale and load .2 Amps to 2 Amps. In N-scale, calculate 1/2Amp, for H0 scale estimate 1 Amp and for larger scales 2 Amps per locomotive, and you will normally have some reserves.
- standing locomotives: without lights 1.5mA, with lights approximately 50mA per light bulb
- rolling stock with lights: per light bulb approximately 50mA

If the output of a single LV101 is not enough to supply the layout, then divide the layout into several power districts. Additional LV101 units then will supply those areas with approximately 52 VA each (one LV per power district)

In the supply area of one LV101, the current load of all simultaneously operating locomotives must not exceed 52 VA (including the current used for lighting in rolling stock).

You have to open the LV101 up to set the track voltage. On the printed circuit board you will find 4 switches. Depending on the position of the 4 switches there is a different starting voltage for the terminals J and K. You will find the positions of the switches needed for each particular voltage printed on the LV101 circuit board and in the following Table. The bold line is the factory default DCC rack voltage.

In order to reach the desired starting voltage, you have to use a transformer whose starting voltage is as high as the desired track-voltage. But do not overdo it: the voltage of the transformer should be adjusted as closely as possible to the desired track-voltage. A transformer voltage which is too high only produces an unnecessary loss of heat in the power station, which would lead to a premature switching off before the maximum amperage is reached.

17.5.6 Connecting the LV101 to other DCC power stations

The LV101 has been designed to be used with a broad range of NMRA DCC systems. Following are diagrams to assist you in connecting the LV101.

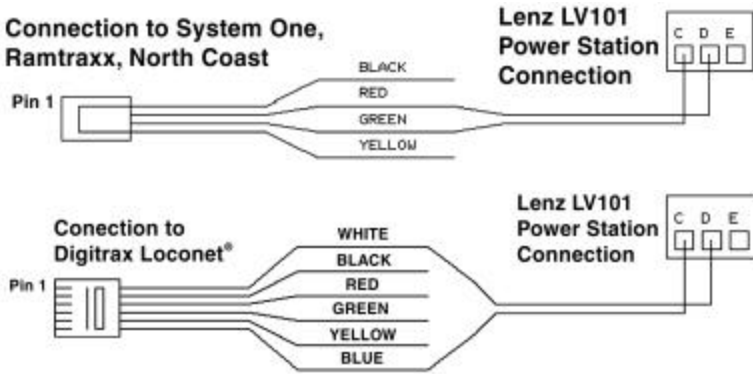

17.6 Advice on the wiring of the model railway

For the connection of the tracks, use only wires with a sufficient cross-section to carry the intended load and slightly twist these cables around each other. The power station (booster) should always be placed as close to the first track feeder as possible.

For extended routes you will need additional feeders at regular distances from each other. Here the following rule of thumb applies:

Size	Feeder every	Minimum cross section of the cable
N	5 ft	18 AGW
H0 / TT	6 ft	16 AGW
S and larger	9 ft	14 AGW

No radio interference suppression capacitor may be in the track system. This capacitor is necessary only for the interference suppression in conventional operation. If used with the **Digital plus by Lenz®** system, however, it would only distort the data format and interfere with the fault-free transmission of data.

Important:

A mixed digital operation using overhead and track lines is not permitted. In such a mode of operation, if the locomotive is sitting on the track facing in the wrong direction (which might be the case for example after having driven through a terminal-loop), the installed locomotive decoder can be destroyed by over-voltage! We recommend operation using track pick-up (wheel contacts), because the reliability of contact (and therefore the transmission of digital signals to the locomotive decoder) is substantially greater than it is when operating with overhead lines.

The heat produced by the amplifier in operation is normal. You must provide sufficient air circulation around the amplifier in order to prevent the internal protective system from reacting prematurely, that is, during normal operation.

Do not leave your model railway system unsupervised when it is in operation! If a short-circuit goes unnoticed, the heat produced creates a fire risk!

17.6.1 Connecting a reverse loop

Lenz GmbH produces an automatic reversing module (LK100) which can be used to easily wire complex automatic reversing sections. While these units are invaluable in some cases they are

not absolutely needed for DCC operations. Following is an example on how a very simple reversing section can be built.

Example:

Using isolated track contacts and a twin-coil relay, the polarity inside a reverse loop is switched such that when crossing the gaps, there is no short. For example; consider the following figure when the train travel is in clockwise direction (turnout is set to diverging route).

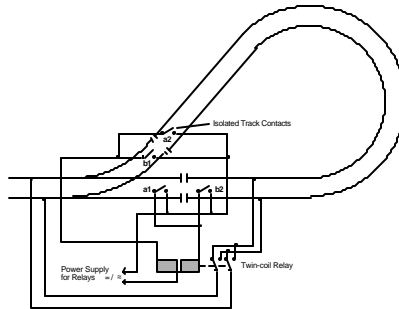

Wiring of Reverse Loops

When passing track contact b1, the polarity of the loop is set to allow the train to cross the gap without a short. As the reverse loop is traversed, track contact 2 will switch the polarity in the loop, and the adjoining gap can be crossed safely. Since in digital operations the direction of travel is dependent on the locomotive and not track polarity, the locomotive will not change its direction of travel when the polarity within the reverse loop is changed.

Travelling the reverse loop counter-clockwise is done in a similar manner, now contacts a1 and a2 ensure that proper polarity is set.

Notes:

The distance between track contacts a2 and b2 must be longer than the longest train that travels the reverse loop.

If the reverse loop is only traversed in one direction, then either contacts a1 and a2 or contacts b1 and b2 are not needed.

The track contacts used in this example can actually be auxiliary contacts set by the switch machine for the switch.

If you wish to traverse the reverse loop with a locomotive without a decoder (analog locomotive), proceed as follows:

- drive the entire train into the reverse loop (the train must be between contacts a2 and b2)
- stop the train and change direction with your handheld (LH100).

- now manually change the polarity in the reverse loop (for example by using push buttons connected in parallel with track contacts a2 and b2)
- continue driving the train through the reverse loop.

You must use this sequence with analog locomotives (non-decoder equipped), since their direction of travel is dependent on track polarity.

17.6.2 Common rail wiring

Normally both rails are gapped between power stations. This provides complete isolation. However, in some scales there exist locomotives that have pickups that are offset from each other. For example many steam locomotives have power pickup from one rail in the locomotive and the other rail in the tender. When such a locomotive bridges the gap between isolated power stations, the locomotive will stall. The solution to this problem is to provide a common wire between all the power stations. All systems of command control need to have a such a common provided, if offset pickup locomotives are to be operated.

Lenz has chosen to leave the option of the location of the common up to the individual operator. The LV101 is completely opto-isolated. This allows you to use one of the rails (called common rail) for your common. Common rail wiring is also compatible with many existing signaling systems. While common rail is the preferred place for a common, you may rather connect all the power station **U** or **V** wires together. This is called common power supply wiring.

Caution: If you decide to install a common, it is important that you only have a single common. Multiple commons (such as common rail and common transformer) should be avoided.

17.7 Mixed operation: conventional DC and digital DCC

Conventional and digital electric circuits must always be thoroughly separated from each other, for example, by installing contact-breaker gaps or insulating rail joiners between digital and analog DC blocks.

In order to prevent the digital operation from being influenced by the normal DC and vice versa, when a sectioning gap is being driven over, install the sectioning module LT100.

At the gap dividing digital from analog operation, you must take steps to prevent interference between the 2 systems when a

locomotive crosses the gap. One approach is to use a Digital Circuit Breaker such as the LT100. If a locomotive bridges the insulated gap, the module immediately interrupts the analog power supply.

Warning:

Mixed digital/analog operations using both rails and catenary (overhead wire) is not allowed. In this mode of operation, if the locomotive is on the track in the wrong direction (for instance after going through a loop), the built-in locomotive decoder could be destroyed by excessive voltage! We suggest you operate with current pickup from the rails (wheel pickups), since that contact is more reliable (and thereby the transmission of the digital signals to the locomotive decoder) than with catenary.

17.8 Wiring the XpressNet Data Network

The XpressNet data network consists of 4 wires, 2 are for the signal and two are for power that is used to power plugged in XpressNet devices.

To install an XpressNet for SET-01 you need to insert an LA152 between the LH200 command station and the LV101 power station. The 4 terminals on the LA152 labeled L,M,A and B are the 4 connections for the XpressNet. Connect these 4 wires to the terminals with the same name on the LA150 connection board.

You can also solder the 4 wires to the DIN-sockets yourself. These sockets are available in electronic-shops or in groups of five as part XP-5 . The assignment of the five-pin DIN-socket is shown in the following figure:

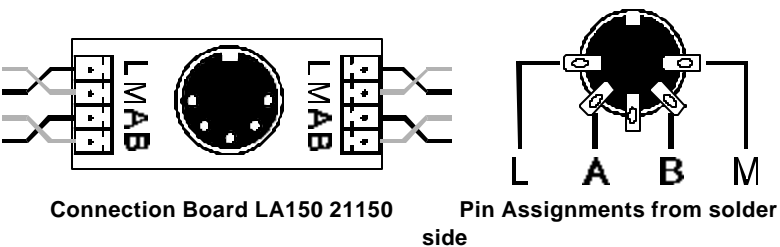

Make sure that you do not mix up the cables of the terminals L and M. This could result in a short in the connected input devices.

The devices exchange information with the command station via the cables at the terminals A and B. The devices are supplied with electricity via the terminals L (plus) and M (minus).

The XpressNet wiring must be installed so that the line starts at the Command Station and ends somewhere on your layout. (Daisy chained from Command Station via intermediate input locations to the last input location.) Between the start and end you may insert connecting panels or 5-pin DIN connectors anywhere. You must not route the wire as a closed loop. Under all circumstances you must ensure that the wires that are connected to terminals **A** and **B** are twisted.

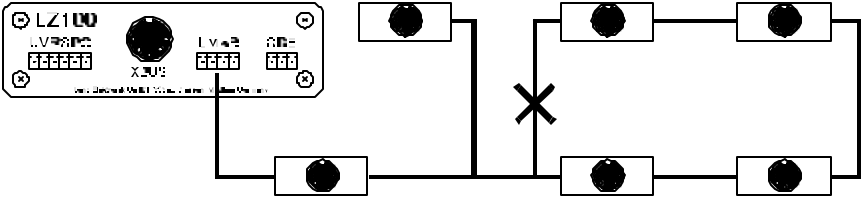

The ends of the XpressNet Network lines A and B should be connected to the resistor which is enclosed with the LA152 adapter. The resistor has a value of 120 Ohm.



Terminating the XpressNet with a resistor

Which cable is to be used for the XpressNet?

The minimum gauge of the wire in the XpressNet should be 24 gauge. You will have to make sure that the cables which you have connected to the terminals A and B are twisted. In practice so-called "bell wire" has proved efficient. This can be acquired cheaply. It is sufficiently twisted and available in various colors.

How long may an XpressNet network be?

For reasons of physics the maximum length of the XpressNet depends on the kind and size of the wires used for the XpressNet. With normal telephone wire the length should not exceed 300 ft. If you install a twin-core, twisted cable for the signal lines of the XpressNet you can increase the length to up to 3000 ft. without problems.

17.9 Bits and bytes - Conversion calculation help

Setting and erasing bits in a CV

Many CVs in the decoders do not use numeric values, but individual bits. If you want to program a decoder that does not support the bit-mode changing of CVs, you must program the decimal value corresponding to the bits that are to be set or erased. This leads to the question:

Which decimal value must be entered to set or erase which bits?

Each set bit represents a number, a value. Simply write out the value of all bits that are to be set in a CV below each other and add them up. In doing so, the following table applies:

bit 0-7	bit 1-8	value
0	1	1
1	2	2
2	3	4
3	4	8
4	5	16
5	6	32
6	7	64
7	8	128

Each bit that is set has a value of '1'. Each bit that is not set has the value '0'. To determine the correct decimal value, the following rule applies:
Add up all the values of all bits that are to be set.

Example

Bit 1 and bit 5 (using 1-8 mode) are to be set, all other bits are to be erased. The values of both set bits are added together. The decimal value that you must program in the CV is '17'.	bit	value
	1	1
	5	16
	Total:	17

17.10 Glossary

The most important terms in the *Digital plus by Lenz*[®] system:

Address	The number of a locomotive, comparable to a telephone number.
Acceleration and deceleration delay	Setting on a locomotive decoder. The acceleration delay determines how fast a locomotive reaches the speed belonging to a higher speed step, the deceleration delay determines how fast a locomotive reaches the speed connected with a lower speed step.
Configuration Variable (CV)	Address, starting voltage, acceleration rate and deceleration rate are examples of features which can be customized within the locomotive decoder. You will find detailed information on the features of Digital plus locomotive decoders in their respective manuals, available from your dealer or direct from Lenz Elektronik GmbH (send a stamped addressed C5 envelope).
DCC	Abbreviation for " D igital C ommand C ontrol". This term has come to refer to the digital model railroad control system developed by Lenz and standardized by the NMRA.
Locomotive address	see address
Locomotive stack	"Index card box" that allows quick selection of a locomotive address.
Multi-unit consist	Controlling several locomotives at the same time with a common address
NMRA	N ational M odel R ailroad A ssociation, North American model railroaders organization
NMRA DCC Standards and RPs	A standard developed by the NMRA based on Lenz Digital plus, which determines the transfer of information to locomotive decoders and accessory decoders. These standards define the interchange of decoders produced by different manufacturers.
Packet format	The manner and method by which the information is transmitted from the command station to the decoder,
Settings in locomotive decoders	see CVs

Throttle positions	The area on the handheld between the minimum and maximum speed is divided into individual sections. We call these throttle positions.
Throttle-notches	Determines whether a locomotive is controlled with 14, 27, 28 or 128 speed step mode.
XpressNet	High speed data communication network for connecting DIGITAL plus input devices together
XpressNet (XBUS) -input devices	Devices that are used to control the model railroad. In the DIGITAL plus system these are: hand held controller, cab tower, interface, etc.

18 Troubleshooting Guide

Malfunction	Possible cause	Correction
SET-01 is not operational (LED on LZ100 and/or LV101 does not light up)	Power supply is interrupted, transformer is not plugged into an outlet or "U", "V" wires are not connected to the transformer.	Ensure that the transformer is on, has not overloaded or shut off, check wiring from transformer to LV101
LED on LV101 flashes and LH100 working properly	The connection between LV101 and command station LZ100 is broken, or there is a short circuit (terminals C and D)	Check and correct these connections.
	There is a power overload and connection E is not connected between the LH100 and the LZ100	Divide the layout into several supply sections and power these with additional power stations/transformers.
LED on LV101 flashes and LH100 in Emergency stop	The emergency Stop key has been pressed on a handheld	Press the emergency stop key again
	There is a power overload and connection E is connected between the LZ100 and the LV101	Divide the layout into several supply sections and power these with additional power station/transformers.
	The Transformer does not have sufficient voltage and or current to power the LV101	Replace the transformer with a higher amp transformer that provides a minimum of 15 volts AC
LV101 is operational (LED solid light), but locomotives do not run	The connection from Power Station to track is broken (terminals J and K).	Test and correct connections.
Controlling locomotives:		
Locomotive does not run	Wrong locomotive address in the display	Enter the correct locomotive address.
	The system is set for 128 speed step operation and the decoder does not support this mode.	Change the system setting for this decoder to 14, 27 or 28 speed step operation depending on the capabilities of the decoder.
The locomotive address is shown in the display, pressing the operation keys gives no response.	You are in the address selection mode, shown by an "A" in the lower row.	Press the 'Enter' key.

Unable to change the speed step mode	The speed of the locomotive is not 0	Set the speed to 0 before setting the speed step mode.
Locomotive does not react when speed step mode 128 is selected	The locomotive decoder does not comprehend this mode (not an XF-type)	Select the 14, 27 or 28 speed step mode for the use of this decoder.
The locomotive lights (F0) turn on and off when the speed steps are increased	The locomotive decoder is set to 14 speed step mode, the corresponding address within the system is set to 28 speed step mode.	Change the speed step mode in the system to 14 speed steps or set the decoder to 28 speed steps (set bit 2 in CV29).
The locomotive lights (F0) do not respond when the  key is pressed.	The locomotive decoder is set to the 28 speed step mode, the corresponding address within the system is set to 14 speed step mode.	Change the speed step mode in the system to 28 speed steps or set the decoder to 14 speed steps (clear bit 2 in CV29).
	The locomotive decoder is set to the 14 speed step mode, the corresponding address within the system is set to 128 speed step mode	Change the speed step mode in the locomotive decoder to 28 speed steps (CV29, set bit 2)
The locomotive does not run with its basic address	The locomotive is possibly part of a multi-unit consist that is not known by the system.	Control the locomotive with the multi-unit consist address
The locomotive address in the display flashes	The selected address is already called up on another hand held controller	Select another locomotive or take over the locomotive: Press one of the speed keys
Programming and reading out decoder settings on the programming track		
When reading an address in menu DIR, the address is preceded by a large "M".	In addition to its own address, the locomotive decoder also has a multi-unit address stored in CV19. An "M" means that this is the locomotive's MU address	You can only control a locomotive in this condition with the MU address. When you see "m" and the locomotive address, press the '-' key and the MU address will be displayed. When you program a new address, the MU address in CV19 is erased.

19 Radio And Television Interference

This equipment has been tested and found to comply with the limits for a Class B digital device, pursuant to Part 15 of the FCC rules. These limits are designed to provide reasonable protection against harmful interference in a residential installation. This equipment generates, uses and can radiate radio interference energy and, if not installed and used in accordance with the instructions, may cause harmful interference to radio communications. However, there is no guarantee that interference will not occur in a particular installation. If this equipment does cause harmful interference to radio or television reception, which can be determined by turning the equipment off and on, the user is encouraged to try to correct the interference by one or more of the following measures:

- Reorient or relocate the receiving antenna.
- Increase the separation between the equipment and the receiver.
- Connect the equipment into an outlet or on a circuit different from that to which the receiver is connected.
- Consult the dealer or an experienced radio/TV technician for help.

You may also find helpful the following booklet, prepared by the FCC: "How to Identify and Resolve Radio-TV Interference Problems." This booklet is available from the U.S. Government Printing Office, Washington D. C. 20402.

Changes and modifications not expressly approved by the manufacturer or registrant of this equipment can void your authority to operate this equipment under Federal Communications Commissions rules.

20 North American Warranty

Lenz GmbH does everything it can do to ensure that its products are free from defects and will operate for the life of your model railroad equipment. From time to time even the best engineered products fail either due to a faulty part or from accidental mistakes in installation. To protect your investment in Digital Plus products, Lenz GmbH offers a very aggressive 10 year Limited Warranty for our North American customers.

Year One: A full repair or replacement will be provided to the original purchaser for any item that that has failed due to manufacturer defects or failures caused by accidental user installation problems. Should the item no longer be produced and the item is not repairable, a similar item will be substituted at the manufacturers discretion. The user must pay for shipping to an authorized Lenz GmbH warranty center.

Year 2 and 3: A full replacement for any item will be provided that has failed due to manufacturer defects. If the failure was caused by accidental user installation or use, a minimal service charge may be imposed. Should the item no longer be produced and the item is not repairable, a similar item will be substituted at the manufacturers discretion. The user must pay shipping to and

from the authorized Lenz GmbH warranty center during this portion of the warranty period.

Year 4-10: A minimal service charge will be placed on each item that has failed due to manufacturer defects and/or accidental user installation problems. Should the item no longer be produced and the item is not repairable, a similar item will be substituted at the manufacturers discretion. The user must pay shipping to and from the authorized Lenz GmbH warranty center during this portion of the warranty period.

This warranty is not valid if the user has altered, intentionally misused the Digital Plus product, or removed the product's protection, for example the heat shrink from decoders and other devices. In this case a service charge will be applied for all repairs or replacements. Should the user desire to alter a Digital Plus Product, they should contact Lenz GmbH for prior authorization.



Please contact your dealer or authorized Lenz GmbH warranty center for specific instructions and current service charges prior to returning any equipment for repair.



**Hüttenbergstrasse 29
35398 Giessen
Germany**

**Hotline: 06403 900 133
Fax: 06403 900 155
info@digital-plus.de**

**Lenz Agency of North America
PO Box 143
Chelmsford, MA 01824 USA**

**Phone: 978 250 1494
Fax: 978 455 LENZ
support@lenz.com**

www.lenz.com



This equipment complies with Part 15 of FCC Rules. Operation is subject to the following two conditions: (1) this device may not cause harmful interference, and (2) this device must accept any interference received, including interference that may cause undesired operation.



Please save this manual for future reference!

© 2000 Lenz GmbH, All Rights Reserved